

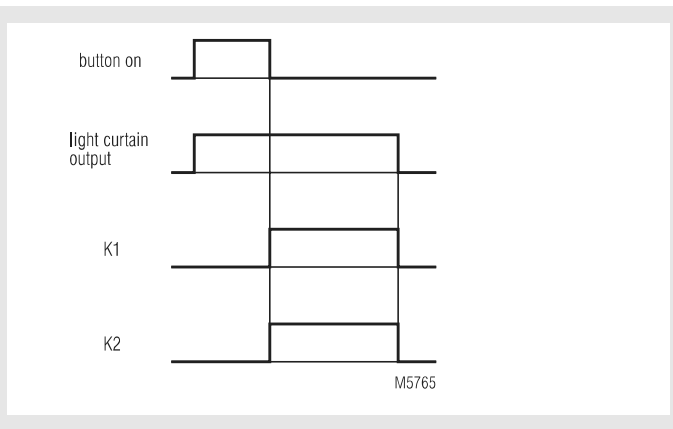

LG 5925/900

Function Diagram



Block Diagram

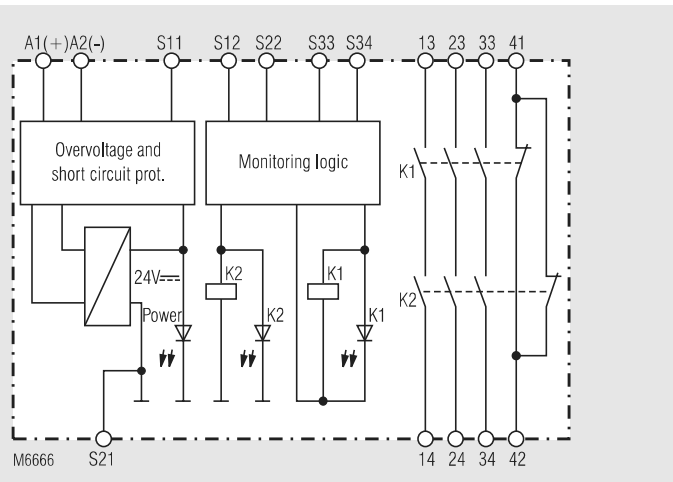

- According to
 - Performance Level (PL) e and category 4 to EN ISO 13849-1: 2008
 - SIL Claimed Level (SIL CL) 3 to IEC/EN 62061
 - Safety Integrity Level (SIL) 3 to IEC/EN 61508
 - Category 4 to EN 954-1
- For light curtains with symmetric or asymmetric outputs adjustment with switch S1
- Output: max. 4 NO contacts, see contacts
- Single and 2-channel operation
- Line fault detection on On-button
- Manual restart or automatic restart, switch S2
- LED indicator for state of operation
- LED indicator for channel 1 and 2 and power
- Removable terminal strips
- Wire connection: also 2 x 1.5 mm² stranded ferruled, or 2 x 2.5 mm² solid DIN 46 228-1/-2/-3/-4
- As option with pluggable terminal blocks for easy exchange of devices
 - with screw terminals
 - or with cage clamp terminals
- Width 22.5 mm

Approvals and Marking



Applications

- Protection of people and machines
- Light curtain controller for light curtains with selftesting (Type 4) according to IEC/EN 61 496-1

Indicators

- upper LED: on when supply connected
lower LEDs: on when relay K1 and K2 energized

Notes

Line fault detection on On-button:
The line fault detection is only active when S12 and S22 are switched simultaneously. If The On-button is closed before S12, S22 is connected to voltage (also when line fault across On-Button), the output contacts will not close. A line fault across the On-button which occurred after activation of the relay, will be detected with the next activation and the output contacts will not close.
ATTENTION ! If a line fault occurs after the voltage has been connected to S12, S22, the unit will be activated because this line fault is similar to the normal On-function.

When using light curtains with asymmetric outputs (one output + switching, one output - switching) the MINUS switching output has to be connected to S22 and the Plus switching to S12.

Circuit Diagrams

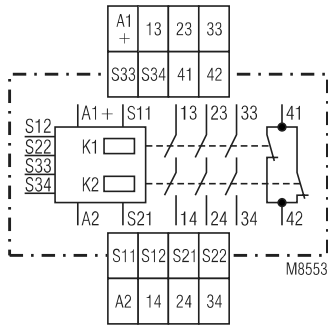

LG 5925/900.48

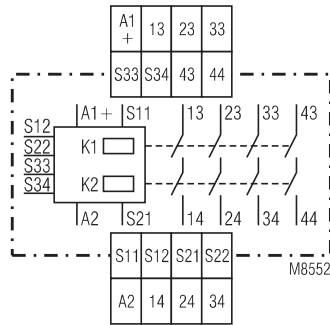

LG 5925/900.04

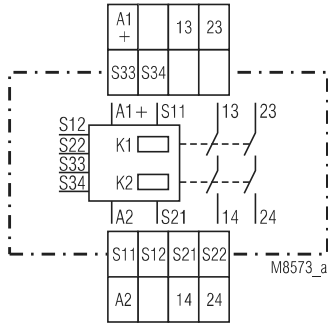

LG 5925/900.02

Connection Terminals

Terminal designation	Signal designation
A1+	+ / L
A2	- / N
S12, S22, S33, S34	Inputs
S11, S21	Outputs
13, 14, 23, 24, 33, 34, 43, 44	Forcibly guided NO contacts for release circuit
41, 42	Forcibly guided indicator output

Setting

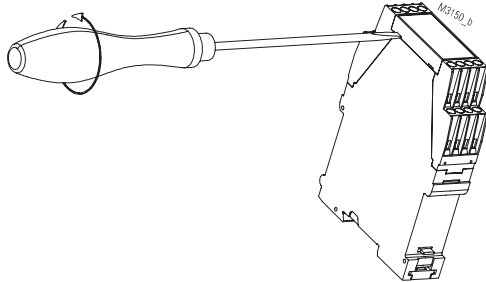
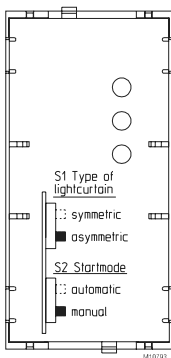

Disconnect unit before setting of S1
Drawing shows setting at the state of delivery

Technical Data

Input circuit

Nominal Voltage U_N:	DC 24 V
Voltage range:	0.9 ... 1.1 U_N
Nominal consumption:	DC approx. 1.7 W
Min. Off-time:	250 ms
Control voltage on S11 at U_N:	DC 22.5 V
Control current typ. over S12, S22:	35 mA at U_N
Min. voltage on S12, S22 when relay activated:	DC 21
Short-circuit protection:	Internal PTC
Overvoltage protection:	Internal VDR

Output

Contacts

LG 5925.02:	2 NO contacts
LG 5925.04:	4 NO contact
LG 5925.48:	3 NO, 1 NC contact

The NO contacts are safety contacts.

ATTENTION! The NC contacts 41-42 can only be used for monitoring

Operate delay typ. at U_N :

Manual start:	20 ms
automatic start:	350 ms

Release delay typ. at U_N :

Disconnecting the supply:	20 ms
Disconnecting S12, S22:	15 ms

Contact type:

forcibly guided

AC 250 V

DC: see limit curve for arc-free operation
max. 8 A per contact
see current limit curve

Thermal current I_{th} :

Switching capacity

to AC 15:

NO contacts:	3 A / AC 230 V	IEC/EN 60 947-5-1
NC contacts:	2 A / AC 230 V	IEC/EN 60 947-5-1

to DC 13:

NO contacts:	2 A / DC 24 V	IEC/EN 60 947-5-1
NC contacts:	2 A / DC 24 V	IEC/EN 60 947-5-1

Electrical contact life

to 5 A, AC 230 V $\cos \varphi = 1$:

> 2.2 x 10⁵ switching cycles

Permissible operating frequency:

max. 1 200 operating cycles / h

Short circuit strength

max. fuse rating:

10 A gL IEC/EN 60 947-5-1

line circuit breaker:

B 6 A

Mechanical life:

> 20 x 10⁶ switching cycles

General Data

Operating mode:

Continuous operation

Temperature range

operation:

- 15 ... + 55 °C

storage :

- 40 ... + 85 °C

altitude:

< 2.000 m

Clearance and creepage distances

Rated impuls voltage /

pollution degree:

4 kV / 2 (basis insulation) IEC 60 664-1

EMC

Electrostatic discharge:

8 kV (air)

IEC/EN 61 000-4-2

HF irradiation:

10 V / m

IEC/EN 61 000-4-3

Fast transients:

2 kV

IEC/EN 61 000-4-4

Surge voltages

between

wires for power supply:

0.5 kV

IEC/EN 61 000-4-5

between wire and ground:

2 kV

IEC/EN 61 000-4-5

Interference suppression:

Limit value class B

EN 55 011

Degree of protection

Housing:

IP 40

IEC/EN 60 529

Terminals:

IP 20

IEC/EN 60 529

Housing:

Thermoplastic with V0 behaviour
according to UL subject 94

Vibration resistance:

Amplitude 0.35 mm IEC/EN 60 068-2-6

frequency 10 ... 55 Hz

Climate resistance:

15 / 055 / 04

IEC/EN 60 068-1

Technical Data

Terminal designation:	EN 50 005
Wire connection	DIN 46 228-1/-2/-3/-4
Screw terminals (integrated):	1 x 4 mm ² solid or 1 x 2.5 mm ² stranded ferruled (isolated) or 2 x 1.5 mm ² stranded ferruled (isolated) or 2 x 2.5 mm ² solid
Wire stripping length:	8 mm
Plug in with screw terminals	
max. cross section for connection:	1 x 2.5 mm ² solid or 1 x 2.5 mm ² stranded ferruled (isolated)
Wire stripping length:	8 mm
Plug in with cage clamp terminals	
max. cross section for connection:	1 x 4 mm ² solid or 1 x 2.5 mm ² stranded ferruled (isolated)
min. cross section for connection:	0.5 mm ²
Wire stripping length:	12 ^{+0.5} mm
Wire fixing:	Plus-minus terminal screws M 3.5 box terminals with wire protection or cage clamp terminals
Mounting:	DIN rail IEC/EN 60 715
Weight:	220 g (DC unit)

Dimensions

Width x height x depth

LG 5925:	22.5 x 90 x 121 mm
LG 5925 PC:	22.5 x 111 x 121 mm
LG 5925 PS:	22.5 x 104 x 121 mm

Safety Related Data

Values according to EN ISO 13849-1:

Category:	4	
PL:	e	
MTTF _d :	584.5	a (year)
DC _{avg} :	99.0	%
d _{op} :	220	d/a (days/year)
h _{op} :	12	h/d (hours/day)
t _{Zyklus} :	3600	s/Zyklus
	≅ 1	/h (hour)

Values according to IEC/EN 62061 / IEC/EN 61508:

SIL CL:	3	IEC/EN 62061
SIL	3	IEC/EN 61508
HFT ¹⁾ :	1	
DC _{avg} :	99.0	%
SFF	99.7	%
PFH _D :	2,66E-10	h ⁻¹
T _r :	20	a (year)

¹⁾ HFT = Hardware-Failure Tolerance



The values stated above are valid for the standard type.
Safety data for other variants are available on request.

The safety relevant data of the complete system has to be determined by the manufacturer of the system.

UL-Data

The safety functions were not evaluated by UL. Listing is accomplished according to requirements of Standard UL 508, "general use applications"

Nominal voltage U_N:	DC 24 V
Ambient temperature:	-15 ... +55°C
Switching capacity	
LG 5925,04/900	
Ambient temperature 35°C:	Pilot duty B300 8A 250Vac Resistive 8A 24Vdc Resistive or G.P.
Ambient temperature 55°C:	Pilot duty B300 4A 250Vac Resistive 4A 24Vdc Resistive or G.P.

LG 5925,02/900, LG 5925,48/900

Ambient temperature 45°C:	Pilot duty B300 8A 250Vac Resistive 8A 24Vdc Resistive or G.P.
Ambient temperature 55°C:	Pilot duty B300 6A 250Vac Resistive 6A 24Vdc Resistive or G.P.

Wire connection:	60°C / 75°C copper conductors only
Screw terminals fixed:	AWG 20 - 12 Sol/Str Torque 0.8 Nm
Plug in screw:	AWG 20 - 14 Sol Torque 0.8 Nm AWG 20 - 16 Str Torque 0.8 Nm
Plug in cage clamp:	AWG 20 - 12 Sol/Str



Technical data that is not stated in the UL-Data, can be found in the technical data section.

Standard type

LG 5925.48/900/61 DC 24 V

Article number:	0063278
• Output:	3 NO contacts, 1 NC contact
• Nominal voltage U _N :	DC 24 V
• Width:	22.5 mm

Ordering Example

LG 5925 /900 /61 DC 24 V

_____	Nominal voltage
_____	UL-approval
_____	Type of terminals
_____	without indication:
_____	terminal blocks fixed
_____	with screw terminals
_____	PC (plug in cage clamp):
_____	pluggable terminal blocks
_____	with cage clamp terminals
_____	PS (plug in screw):
_____	pluggable terminal blocks
_____	with screw terminals
_____	Contacts
_____	Type

Options with Pluggable Terminal Blocks

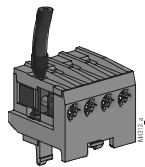

Screw terminal
(PS/plugin screw)

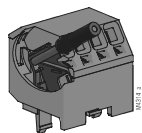

Cage clamp terminal
(PC/plugin cage clamp)

Notes

Removing the terminal blocks with cage clamp terminals

1. The unit has to be disconnected.
2. Insert a screwdriver in the side recess of the front plate.
3. Turn the screwdriver to the right and left.
4. Please note that the terminal blocks have to be mounted on the belonging plug in terminations.

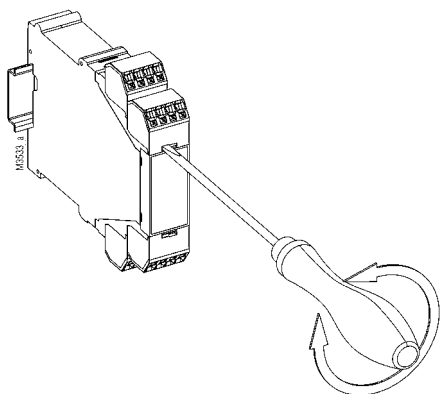

Characteristics

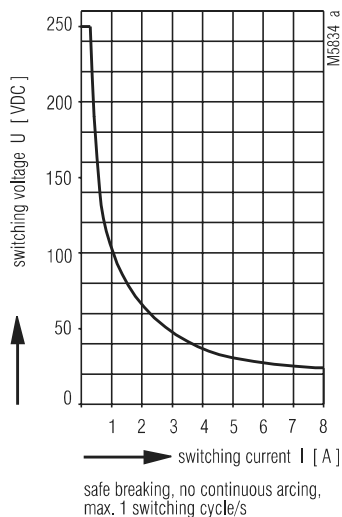

Arc limit curve under resistive load

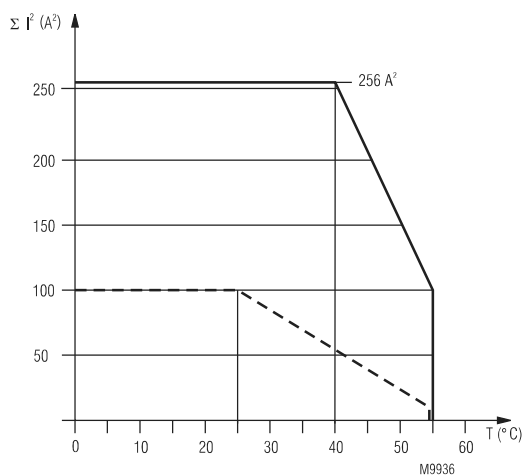

— device mounted on distance with air circulation.
max. current at 55°C over
4 contactrows = 5A $\hat{=}$ 4x5²A² = 100A²

— device mounted without distance heated by
devices with same load,
max current at 55°C over
4 contactrows = 1A $\hat{=}$ 4x1²A² = 4A²

$$\Sigma I^2 = I_1^2 + I_2^2 + I_3^2 + I_4^2$$

I_1, I_2, I_3, I_4 - current in contactrows

Total current limit curve

Application Examples

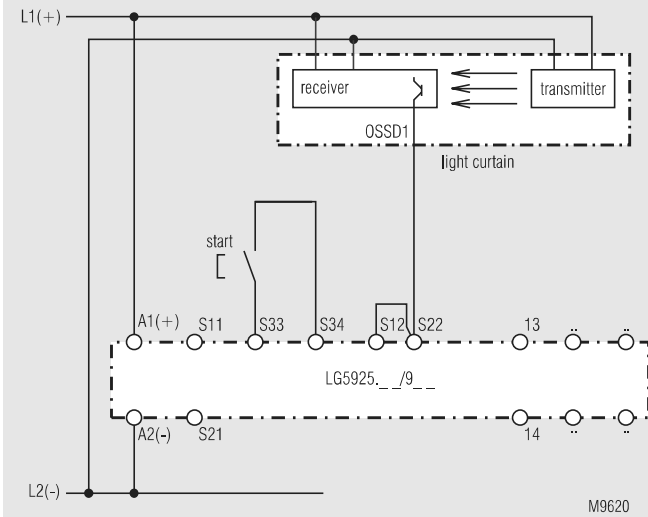

Single channel connection of light curtains with selftest according to EN 61 496-1.

Note: Refer to "Unit programming"!

Switches in pos.: S1 "symmetrical"
S2 "manual"

With autostart link S33 - S34 set to "automatic".
Suited up to SIL2, Performance Level d, Cat. 2

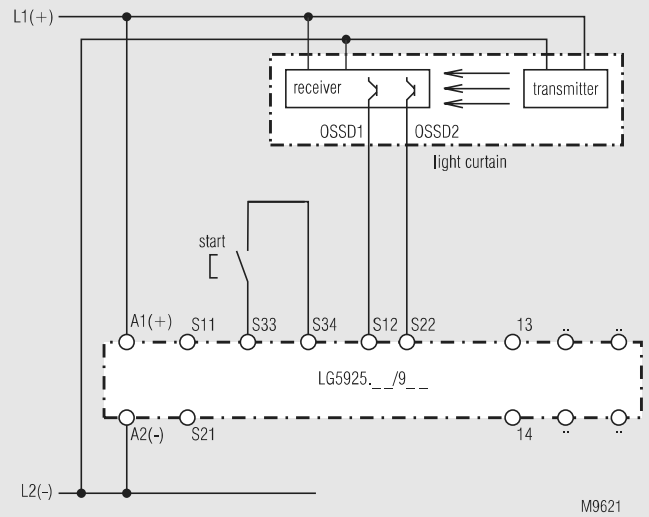

2channel connection of light curtains with selftest according to EN 61 496-1.

Cross fault detection in the light curtain.

Note: Refer to "Unit programming"!

Switches in pos.:

S1: With symmetric outputs on light curtain switch S1 in position "symmetrical" with asymmetric outputs on light curtains switch S1 in position "asymmetric".

S2: "manual"

Suited up to SIL3, Performance Level e, Cat. 4

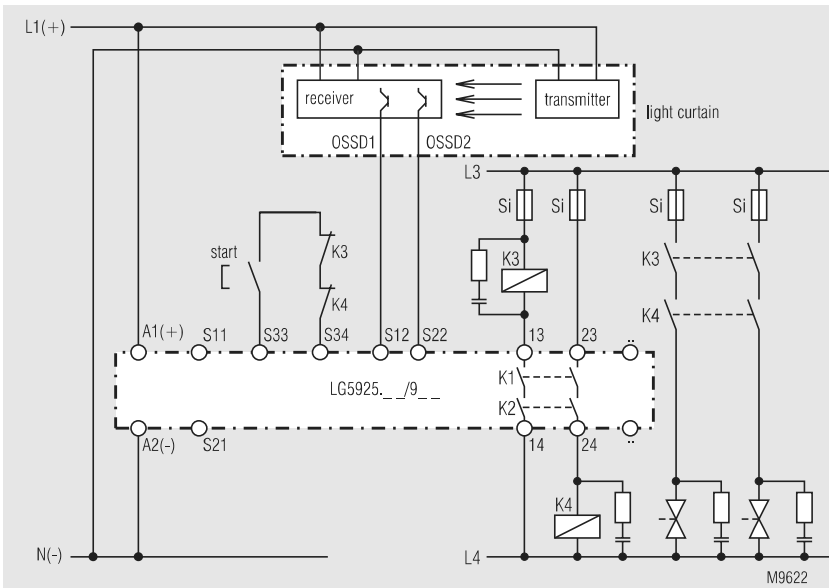

Contact reinforcement and contact extension by external contactors

Note: Refer to "Unit programming"!

Switches in pos.:

Switches in pos.:

S1: With symmetric outputs on light curtain switch S1 in position "symmetrical" with asymmetric outputs on light curtains switch S1 in position "asymmetric".

S2: "manual"

Suited up to SIL3, Performance Level e, Cat. 4

