

POWERSWITCH

Reversing Contactor With Softstart And Active Power Monitoring BI 9254



- According to IEC/EN 60 947-1, IEC/EN 60 947-4-2
- To reverse 3 phase motors
- Electrical interlocking of both directions
- 2-phase softstart
- Active power monitoring after softstart
- Temperature monitoring of power semiconductors
- LED indicator
- Internal auxiliary voltage are made from phase voltage
- Galvanic separation of control circuit and power circuit
- Space and cost saving with 3 functions in one compact unit
- Reducing of wiring and wiring failure
- Width 90 mm

Function Diagrams

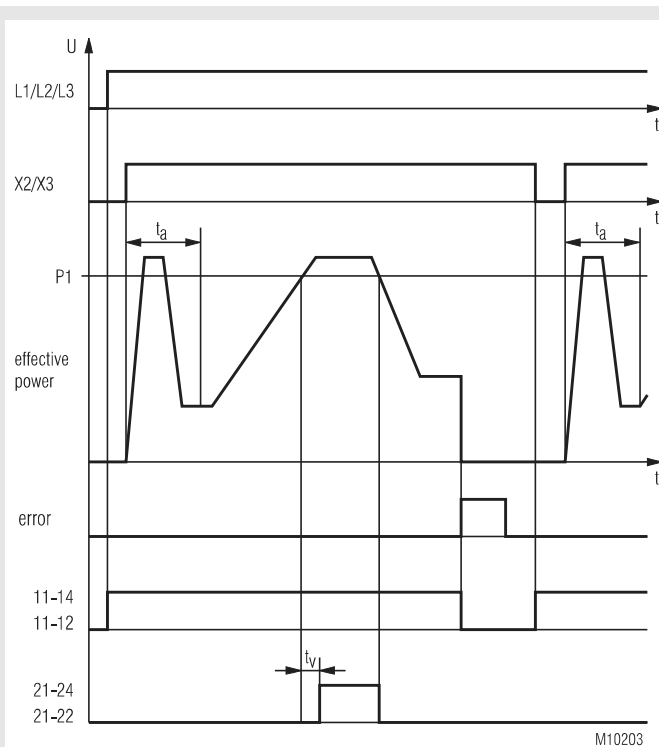

M10203

P1 = minimum response value

t_a = start up delay

t_v = delay on energisation

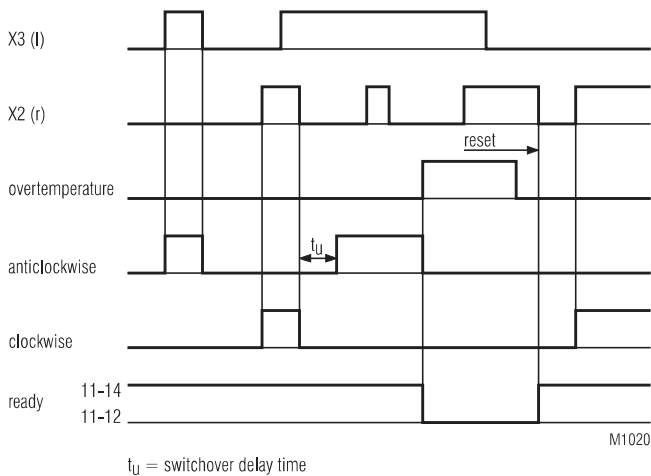

M10202

Approvals and Marking

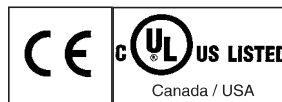

Applications

- Reversing operation for door and gate controls, bridge drives and lifting applications with monitoring of blockage
- Conveyor systems with monitoring of blockage
- Actuating drives in process controls with blockage monitoring

Circuit Diagram

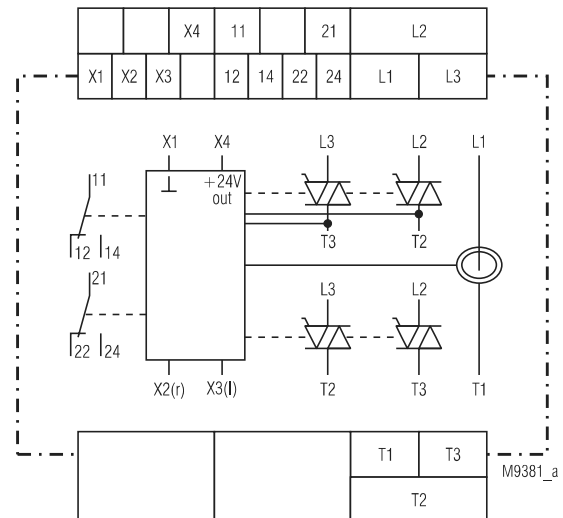

M9381_a

Function

The reversing contactor BI 9254 is used to reverse the direction and to monitor the effective power on 3-phase asynchronous motors. An electrical interlock blocks the simultaneous control of both directions. To monitor the effective power correctly the current in the 3 phases has to be symmetric. The monitoring function only gets active after an adjustable start up delay. The 3 phases L1, L2 and L3 are connected continuously to the unit.

Temperature monitoring

To protect the semiconductors their temperature is monitored. If overtemperature is detected, the power semiconductors switch off, the signalling relay 1 de-energises and the red LED flashes Code 1. This state is latched. After the temperature is back to normal the status can be reset by switching the control input on and off.

Softstart

Two phases are controlled by thyristors in order to let the current rise slowly and to limit it. The motor torque reacts accordingly during start-up. This allows to reduce shock and stress for the mechanical parts of the drive. Start-up time and starting torque can be set with potentiometers.

Effective load measuring

After an adjustable start up time, but at the earliest after end of ramp up time, the effective power of the connected motor is monitored. The effective power is defined as $P = U \times I \times \cos\phi$. The maximum motor load is adjustable with potentiometer. A yellow LED indicates overload, but only as long as the motor is actually in overload state. After an adjustable time delay of 1...10 s a relay contact switches on until the effective load drops again under the adjusted value.

Control inputs

With 2 control inputs left and right rotation is selected. When both inputs are activated the first signal will be accepted as valid. The inputs can be controlled by volt free contacts or with external DC 24 V. With activation of a control input the ramp up time and the start up delay is started again. The unit does not create any extra interlocking times for reversing operation except a short delay that is necessary to control the semiconductors. If one or both control inputs are active when applying auxiliary supply, a failure code "Control input active when unit switched on" is displayed. The Error LED flashes code 6. By disconnecting the control inputs the failure state is reset.

Monitoring relay 1 (contact 11-12-14)

The relay energises as soon as the unit is ready for operation after auxiliary supply is connected. On overtemperature, phase failure or wrong phase sequence the relay de-energises and the power semiconductor switches off.

Monitoring relay 2 (contact 21-22-24)

The relay energises, when after the adjusted time delay the effective power exceeds the setting value (energized on trip). The relay de-energises as soon as the effective power drops below the adjusted value. In the case of any other failure the relay de-energises.

Indication

green LED ON:	permanent on	- supply connected
	flashing	- start up delay active
yellow LED r:	permanent on	- after start clockwise
	flashing	- during start clockwise
yellow LED l:	permanent on	- after start anticlockwise
	flashing	- during start anticlockwise
yellow LED >P _{max} :	permanent on	- effective power overload, relay 2 energized
	flashing	- delay active
red LED ERROR:	flashing	- Error
	1*)	- overtemperature on semiconductors
	2*)	- wrong mains frequency
	3*)	- incorrect phase sequence, exchange connections on L1 and L2
	4*)	- phase failure
	5*)	- Temperature monitoring of power semiconductors defect or device temperature < -20 °C
	6*)	- control input energized on power up

1*) - 6*) = Number of flashing pulses in sequence

Setting Facilities

Poti M _{on} :	- starting torque at softstart 20 ... 80 %
Poti t _{on} :	- ramp up time 1 ... 10 s
Poti t _a :	- start up time delay 1 ... 20 s
Poti t _v :	- on delay 1 ... 10 s
Poti P _{max} :	- response value for max. effective power 0,1 ... 6 kW

The setting of the effective power is infinite adjustable on absolute scale. The most accurate setting is achieved by turning the pot slowly from min to required value without changing the turning direction.

Set-up Procedure

1. Connect motor and device according to application example. Turn potentiometer M_{on} fully anticlockwise, potentiometers t_{on}, t_a, t_v and P_{max} fully clockwise.
2. Connect voltage and begin softstart by control of input X2 or X3. Turn potentiometer clockwise until motor starts immediately after switching on. This avoids unnecessary heating and humming of the motor.
3. Adjust the start up time by turning t_{on} to the required value. At correct setting, the motor should ramp up continuously to full speed.
4. Adjust the start up time delay with potentiometer t_a, time delay with potentiometer t_v and response value for max. effective power with potentiometer P_{max} to the required value.

Safety Remarks

- Never clear a fault when the device is switched on

Attention: This device can be started by potential-free contact, while connected directly to the mains without contactor (see application example). Please note, that even if the motor is at rest, it is not physically separated from the mains. Because of this the motor **must** be disconnected from the mains via the corresponding manual motor starter.



- The user must ensure that the device and the necessary components are mounted and connected according to the locally applicable regulations and technical standards (VDE, TÜV, BG).
- Adjustments may only be carried out by qualified specialist staff and the applicable safety rules must be observed.

Technical Data

Nominal voltage L1/L2/L3: 3 AC 400 V ± 10 %
Nominal frequency: 50 / 60 Hz automatische Erkennung

Load Output

		with heat sink width: 67,5 mm	
Rated continuous current $I_b^{(1)}$ [A]		12	
Ambient temperature [°C]		40	60
max. motor power at 400 V [kW]		5,5	3
Nominal motor current I_N [A]		11,5	6,6
max. locked rotor motor current $I_A^{(2)}$ [A]		69	39,6
Example for max. operat. freq. at 100 % duty cycle, 80 % motor load, starting time t_A 2s, starting current $I_A = 6 \times I_N$ [1/h]		84	
Operation mode		AC53a acc. to IEC/EN 60947-4-2	

¹⁾ The rated continuous current I_b is the max. permissible current of the unit in continuous operation.

²⁾ The max. locked rotor motor or starting current of 100 A for 1 s, 85 A for 2 s and 70 A for 5 s must not be exceeded.

Note: The max. permissible operating frequency of the motor can be less. See motor data!

Peak reverse voltage: 1200 V
Overvoltage limiting: AC 510 V
Surge current 10 ms: 300 A
Semiconductor fuse: e.g. TRS 25R Fa. Ferraz
Leakage current in off state: < 3 x 5 mA
Internal resistance
current measuring system: 7 mΩ
Starting voltage: 20 ... 80 %
Ramp up time: 1 ... 10 s
Consumption: 3 W
Interlocking time t_u : 50 ms
Start up delay: max. 25 ms
Release delay: max. 30 ms
Effective power monitoring
 Measuring accuracy: ± 4 % max. scale value
 Reaction time: 80 ms

Cycle diagram to calculate the operating frequency

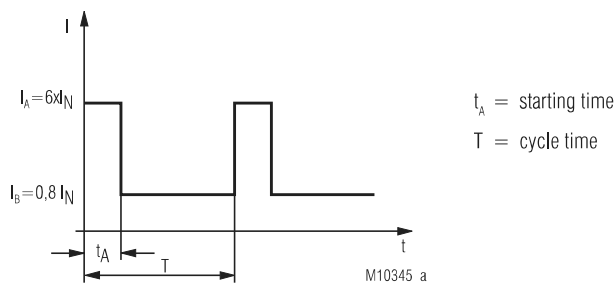

Formula for selection of unit and motor

$$I_b \geq \frac{1}{T} [I_A t_A + I_B (T - t_A)] \quad \text{Device selection}$$

$$I_N^2 \geq \frac{1}{T} [I_A^2 t_A + I_B^2 (T - t_A)] \quad \text{Motor selection}$$

Inputs

Control input right, left: DC 24 V "volt free contact"
 Rated current: 5 mA
 Softstart: DC 10 ... 30 V
 Softstop: DC 0 ... 6 V
 Connection: polarity protected diode, overvoltage protection
 Volt free kontakt: NO contact

Technical Data

Indicator Output

Contacts: 2 x 1 change over contacts
Thermal current I_{th} : 5 A
Switching capacity
 to AC 15
 NO contact: 3 A / AC 230 V IEC/EN 60 947-5-1
 NC contact: 1 A / AC 230 V IEC/EN 60 947-5-1
Elektrical life
 to AC 15 at 3 A, AC 230 V: 2 x 10⁵ switch. cycles IEC/EN 60 947-5-1
Mechanical life: 30 x 10⁶ switching cycles
Permissible switching frequency: 1800 switching cycles/h
Short circuit strength
 max. fuse rating: 4 A gL IEC/EN 60 947-5-1

General Data

Operating mode: Continuous operation
Temperature range: - 20 ... + 60 °C
 Current reduction over 40 °C: see table

Clearance and creepage distances

overvoltage category /
contamination level

Motor voltage-heat sink: 6 kV / 2 EN 50 178
 Motor voltage-control voltage: 4 kV / 2 EN 50 178

EMC

Electrostatic discharge (ESD): 8 kV (Luftentladung) IEC/EN 61 000-4-2
 Fast transients: 2 kV IEC/EN 61 000-4-4

Surge voltage
between

wires for power supply: 1 kV IEC/EN 61 000-4-5
 between wire and ground: 2 kV IEC/EN 61 000-4-5
 HF-wire guided: 10 V IEC/EN 61 000-4-6

Radio interference:
Radio interference voltage:
Harmonics: EN 55 011
EN 55 011
EN 61 000-3-2

Degree of protection

Housing: IP 40 IEC/EN 60 529
 Terminals: IP 20 IEC/EN 60 529

Vibration resistance:

Amplitude 0,35 mm
 frequency 10 ... 55 Hz, IEC/EN 60 068-2-6
 20 / 055 / 04 IEC/EN 60 068-1

Climate resistance:

Wire connection

Load terminals: 1 x 10 mm² solid or
 1 x 6 mm² stranded wire with sleeve
 Control terminals: 1 x 4 mm² solid or
 1 x 2,5 mm² stranded ferruled (isolated) or
 2 x 1,5 mm² stranded ferruled (isolated) or
 2 x 2,5 mm² stranded wire with sleeve
 DIN 46 228-1/-2/-3/-4

Wire fixing

Load terminals: Captive plus-minus-terminal screws M4;
 Box terminals with self-lifting wire
 protection
 Control terminals: Captive plus-minus-terminal screws M3,5;
 Box terminals with self-lifting wire protection

Mounting:

Hutschiene IEC/EN 60 715

Dimensions

Width x height x depth: 90 x 85 x 121 mm

UL-Data

	with heat sink width: 67,5 mm	
Switching capacity	400; 3-phase 50/60 Hz	
Motor (Motor circuit) [Vac]	---	
Relay		
NO-contact [Vac]	230; 3A; GP	
NC-contact [Vac]	230; 3A; GP	
Short circuit current rating [Arms]	5000	
Ambient conditions	For usage at pollution degree 2; To be used in circuits that allows a max. current of 5000Arms at 400 V. The device has to be fused with a fuse class RK5 25A.	
Rated continuous current I_o ¹⁾ [A]	12	
Ambient temperature [°C]	40	60
max. motor power at 400 V [HP]	3	2
Nominal motor current FLA (Full load current) [A]	6,1	4,3
max. locked rotor motor current LRA ²⁾ [A]	43	34
Example for max. operat. freq. at 100 % duty cycle, 80 % motor load, starting time t_s 2s, starting current $I_A = 6 \times I_N$ [1/h]	245	

¹⁾ The rated continuous current I_o is the max. permissible current of the unit in continuous operation.

²⁾ The max. locked rotor motor or starting current of 100 A for 1 s, 85 A for 2 s and 70 A for 5 s must not be exceeded.

Wire connection

Load terminals:

60°C / 75°C copper conductors only
AWG 18 - 8 Sol Torque 0.8 Nm
AWG 18 - 10 Str Torque 0.8 Nm

Control terminals:

60°C / 75°C copper conductors only
AWG 20 - 12 Sol Torque 0.8 Nm
AWG 20 - 14 Str Torque 0.8 Nm



Technical data that is not stated in the UL-Data, can be found in the technical data section.

Standard Type

BI 9254.38 3 AC 400 V 50 / 60 Hz 12 A

Article number: 0059430

- Nominal voltage: 3 AC 400 V
- Rated continuous current: 12 A
- Control voltage: DC 24 V or contact
- Width: 90 mm

Order Reference

BI 9254 .38 3 AC 400 V 50 / 60 Hz 12 A

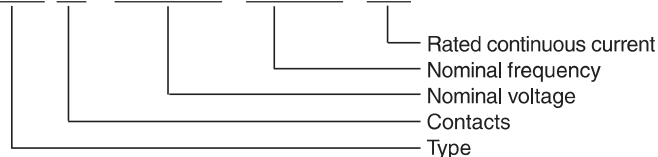

Application Examples

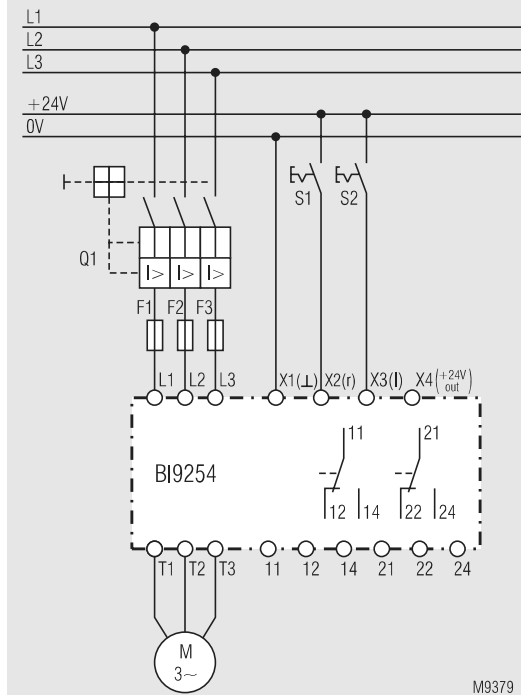

BI 9254 with control input DC 24 V

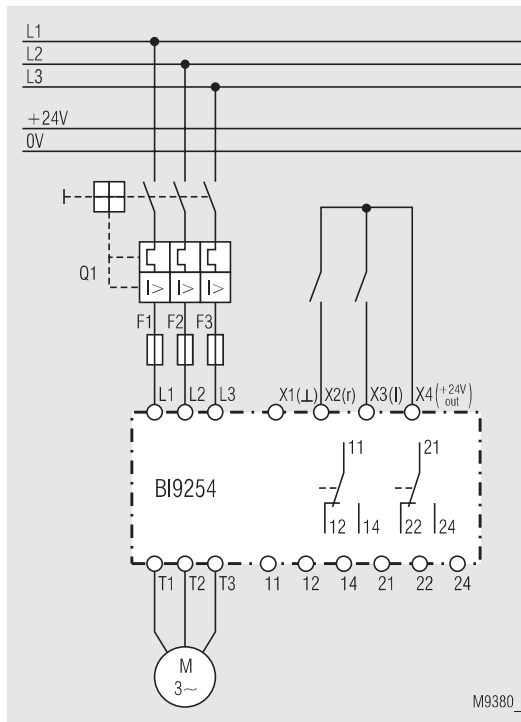

BI 9254 with volt free contact