

VARIMETER IMD Insulation Monitor IL 5880, IP 5880, SL 5880, SP 5880

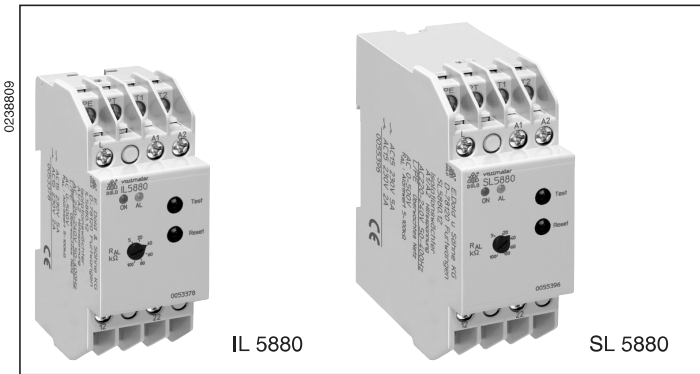

- According to IEC/EN 61 557
- For single and 3-phase AC-systems up to 0 ... 500 V and 10 ... 3000 Hz
- Adjustable tripping value R_{AL} of 5 ... 100 k Ω
- Monitors also disconnected voltage systems
- De-energized on trip
- Auxiliary voltage Measuring Circuit and output contacts are galvanically separated
- Manual and auto reset
- With test and reset button
- Connections of external test and reset buttons possible
- LED indicators for operation and alarm
- 2 changeover contacts
- IL/SL 5880/200 with additional prewarning
 - adjustable prewarning value 10 k Ω ... 5 M Ω
 - output function programmable
- Variant IL/SL 5880/300 according to DIN VDE 0100-551 for mobile generator sets available

Circuit Diagram

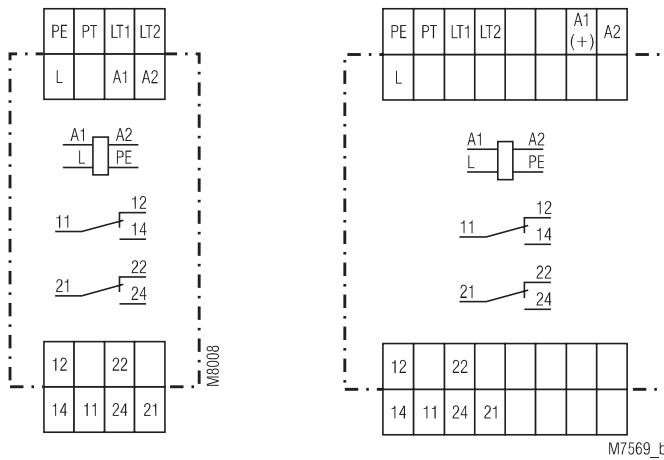

IL 5880, SL 5880

IP 5880, SP 5880

- **4 models available:**
 - IL 5880, IP 5880:** 61 mm deep with terminals near to the bottom to be mounted in consumer units or industrial distribution systems according to DIN 43 880
 - SL 5880, SP 5880:** 98 mm deep with terminals near to the top to be mounted in cabinets with mounting plate and cable ducts

- 35 mm width

Approvals and Marking



*) only IL 5880 and IP 5880

Applications

- Monitoring of insulation resistance of ungrounded voltage systems to earth.
- IL/SL 5880/200 can also be used to monitor standby devices for earth fault, e.g. motor windings of devices that have to function in the case of emergency.
- IL/SL 5880/300 according to DIN VDE 0100-551 to monitor mobile generator systems
- Other resistance monitoring applications.

Function

The device is connected to the supply via terminals A1-A2. The unit can either be supplied from the monitored voltage system or from an separate auxiliary supply. Terminal L is connected to the monitored voltage and PE to earth. If the insulation resistance R_E drops below the adjusted alarm value R_{AL} the red LED goes on and the output relay switches off (de-energized on trip). If the unit is on auto reset (bridge between LT1-LT2) and the insulation resistance gets better (R_E rises), the insulation monitor switches on again with a certain hysteresis and the red LED goes off. Without the bridge between LT1-LT2 the Insulation monitor remains in faulty state even if the insulation resistance is back to normal. (In order to achieve failure storage, the voltage system showing a fault must not be switched off too fast after detection of the failure, see notes). The reset is done by pressing the internal or external reset button or by disconnecting the auxiliary supply. By activating the "Test" button an insulation failure can be simulated to test the function of the unit.

The variants IL/SL 5880.12/200 have a second setting range with a higher resistance up to 5 M Ω (Potentiometer R_{VW}). This setting value can be used for pre-warning with relay output, by positioning the lower setting switch to "AL 11-12-14; VW 21-22-24".

If the higher setting range should be used only, the setting switch is put in position "VW 2u" and both contacts react only to the higher setting.

If the lower setting range should be used only, the setting switch is put in position "AL 2u" and both contacts react only to the lower setting.

When set to manual reset the latching is active on both settings R_{AL} and R_{VW} . Therefore it is possible in the case of a short insulation decrease (Switch position AL 11-12-14; VW 21-22-24), to pass the warning signal to a PLC while the main fault does not lead to a disconnection of the mains via the contacts 11-12-14.

Function Diagram

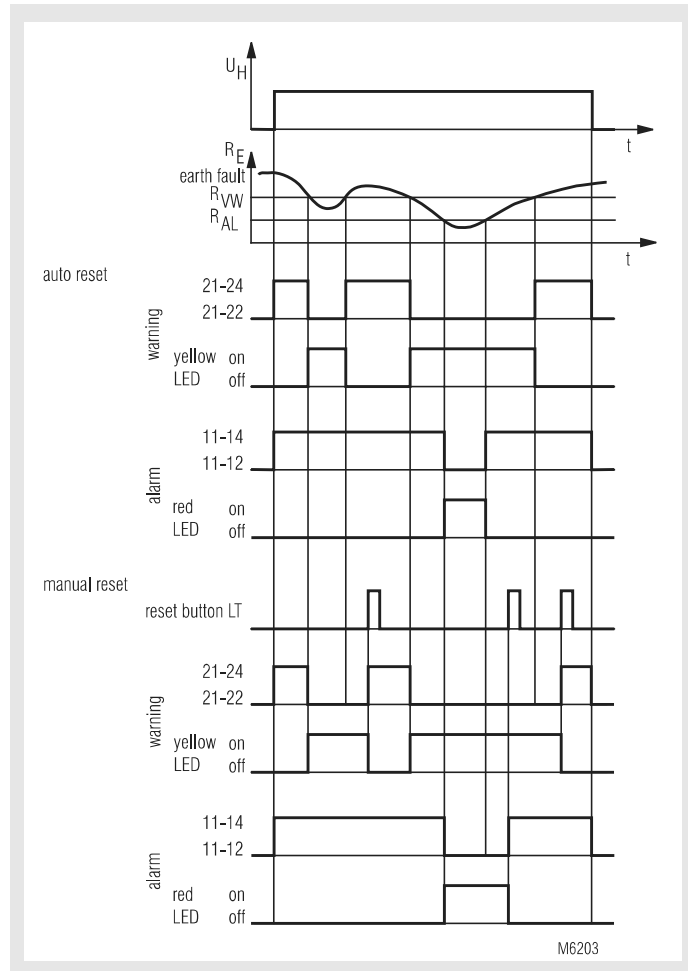
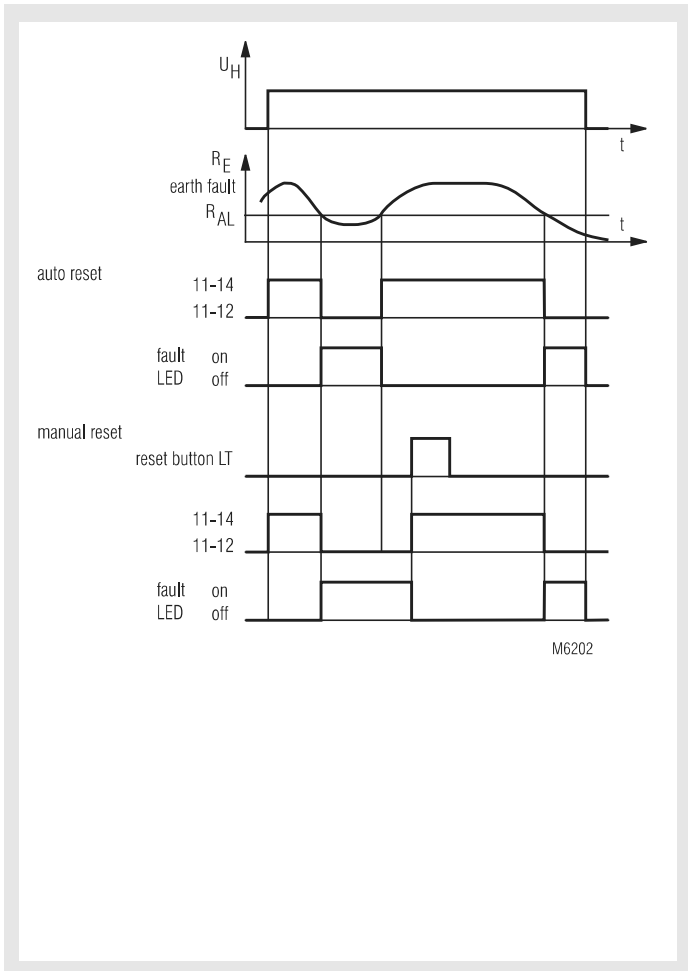

IL 5880, SL 5880, IP 5880, SP 5880

IL 5880/200, SL 5880/200, IP 5880/200, SP 5880/200

Indicators

Green LED "ON":	On, when supply voltage connected
Red LED "AL":	On, when insulation fault detected, ($R_E < R_{AL}$)
Yellow LED "VW":	On, when insulation resistance is under prewarning value, $R_E < R_{VW}$ (only with variant IL/SL 5880.12/2_ and /300)

Notes

Storing of insulation failures:
The storing of an insulation failure is delayed slightly longer the reaction of the output relay because of interference immunity. In cases where the defective voltage system is switched off immediately by the output of the insulation monitor it can happen that the fault is not stored (e. g. mobile generator sets). For these applications we recommend the variant IL/SL 5880/300, where the output relay reacts only after the fault is stored. All other features of this variant are similar to IL/SL 5880/200.

The Insulation monitors IL/SL 5880 are designed to monitor AC-voltage systems. Overlaid DC voltage does not damage the instrument but may change the conditions in the Measuring Circuit. In one voltage system only one Insulation monitor must be connected. This has to be observed when coupling voltage system.

Line capacitance C_E to ground does not influence the insulation measurement, as the measurement is made with DC-voltage. It is possible that the reaction time in the case of insulation time gets longer corresponding to the time constant $R_E * C_E$.

The model /200 can be used, because of its higher setting value, to monitor single or 3-phase loads for ground fault.

If the load is operated from a grounded system the insulation resistance of the load can only be monitored when disconnected from the mains. This is normally the fact with loads which are operated seldom or only in the case of emergency but then must be function (see connection example).

The auxiliary supply can be connected to a separate auxiliary supply or to the monitored voltage system. The range of the auxiliary supply input has to be observed.

When monitoring 3-phase IT systems it is sufficient to connect the insulation monitor only to one phase. The 3-phases have a low resistive connection (approx. 3 - 5 Ω) via the feeding transformer. So failures that occur in the non-connected phases will also be detected.

Technical Data

Auxiliary Circuit

Nominal voltage U_N

IL 5880, SL 5880: AC 220 ... 240 V, AC 380 ... 415 V
0.8 ... 1.1 U_N
DC 12 V, DC 24 V

IP 5880: AC / DC 110 ... 240 V
0.7 ... 1.25 U_N
45 ... 400 Hz

Frequency range (AC):

Nominal consumption:

AC: approx. 2 VA
DC: approx. 1 W

Measuring Circuit

Nominal voltage U_N : AC 0 ... 500 V

Voltage range: 0 ... 1.1 U_N

Frequency range: 10 ... 3000 Hz

Alarm value R_{AL} : 5 ... 100 k Ω

Prewarning value R_{VW}
(only at IL/SL 5880/2__
and IL/SL 5880/300):

Setting R_{AL} , R_{VW} : 10 k Ω ... 5 M Ω

Setting R_{AL} , R_{VW} : infinite variable

Internal test resistor: equivalent to earth resistance of < 5 k Ω

Internal AC resistance: > 250 k Ω

Internal DC resistance: > 250 k Ω

Measuring voltage: approx. DC 15 V, (internally generated)

Max. measuring current

($R_E = 0$): < 0.1 mA

Max. permissible noise

DC voltage: DC 500 V

Operate delay

at $R_{AL} = 50$ k Ω , CE = 1 μ F

R_E from ∞ to 0.9 R_{AL} : < 1.3 s

R_E from ∞ to 0 k Ω : < 0.7 s

Hysteresis

at $R_{AL} = 50$ k Ω : approx. 15 %

Output

Contacts:

IL / SL 5880.12,
IP / SP 5880.12: 2 changeover contacts

IL / SL 5880.12/2__
IL / SL 5880.12/300,
IP / SP 5880.12/2__ : 2 x 1 changeover contact,
programmable

Thermal current I_{th} : 4 A

Switching capacity

to AC 15

NO: 5 A / AC 230 V IEC/EN 60 947-5-1

NC: 2 A / AC 230 V IEC/EN 60 947-5-1

Electrical life

to AC 15 at 1 A, AC 230 V: $\geq 5 \times 10^5$ switching cycles IEC/EN 60 947-5-1

Short circuit strength

max. fuse rating: 4 A gL IEC/EN 60 947-5-1

Mechanical life: $\geq 30 \times 10^6$ switching cycles

General Data

Operating mode: Continuous operation

Temperature range: - 20 ... + 60°C

Clearance and creepage distances

rated impuls voltage /
pollution degree IEC 60 664-1

between auxiliary supply
connections (A1- A2): 4 kV / 2 at AC-auxiliary voltage

between measuring input
connections (L - PE): 4 kV / 2 IEC 60 664-1

between auxiliary supply
and measuring input
connections: 4 kV / 2 IEC 60 664-1

connections: 4 kV / 2 (3 kV at DC-auxiliary voltage)

Technical Data

EMC

Electrostatic discharge: 8 kV (air) IEC/EN 61 000-4-2

HF irradiation: 10 V / m IEC/EN 61 000-4-3

Fast transients: 2 kV IEC/EN 61 000-4-4

Surge voltages

between A1 - A2: 1 kV IEC/EN 61 000-4-5

between L - PE: 1 kV IEC/EN 61 000-4-5

Interference suppression: Limit value class B EN 55 011

Degree of protection:

Housing: IP 40 IEC/EN 60 529

Terminals: IP 20 IEC/EN 60 529

Housing:

Thermoplastic with V0 behaviour

according to UL Subjekt 94

Vibration resistance: Amplitude 0.35 mm

frequency 10 ... 55 Hz IEC/EN 60 068-2-6

20 / 060 / 04 IEC/EN 60 068-1

Climate resistance: 20 / 060 / 04 IEC/EN 60 068-1

Terminal designation: EN 50 005

Wire connection: 2 x 2.5 mm² solid or

2 x 1.5 mm² stranded wire

DIN 46 228-1/-2/-3/-4

Wire fixing: Flat terminals with self-lifting

clamping piece IEC/EN 60 999-1

DIN rail IEC/EN 60 715

Mounting: IL 5880: 160 g

SL 5880: 189 g

IP 5880: 250 g

SP 5880: 300 g

Dimensions

Width x height x depth:

IL 5880: 35 x 90 x 61 mm

SL 5880: 35 x 90 x 98 mm

IP 5880: 70 x 90 x 61 mm

SP 5880: 70 x 90 x 98 mm

Standard Types

IL 5880.12 AC 220 ... 240 V

Article number: 0053378 stock item

• Auxiliary voltage U_H : AC 220 ... 240 V

• adjustable

alarm value R_{AL} : 5 ... 100 k Ω

• Width: 35 mm

SL 5880.12 AC 220 ... 240 V

Article number: 0055396

• Auxiliary voltage U_H : AC 220 ... 240 V

• adjustable

alarm value R_{AL} : 5 ... 100 k Ω

• Width: 35 mm

Variants

IL / SL 5880.12/200: with pre-warning and programmable
outputs

IL / SL 5880.12/201: as version IL / SL 5880.12/200, but
both output relays with energized on Trip
principle

IL / SL 5880.12/300: according to DIN VDE 0100-551
as version IL / SL 5880.12/200, but
for use with mobile generator sets

Ordering example for variants

IL 5880 .12 / _ _ _ AC 380 ... 415 V AL 5 ... 100 k Ω VW 10 K ... 5M Ω

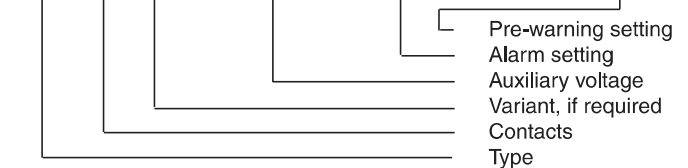

Connection Examples

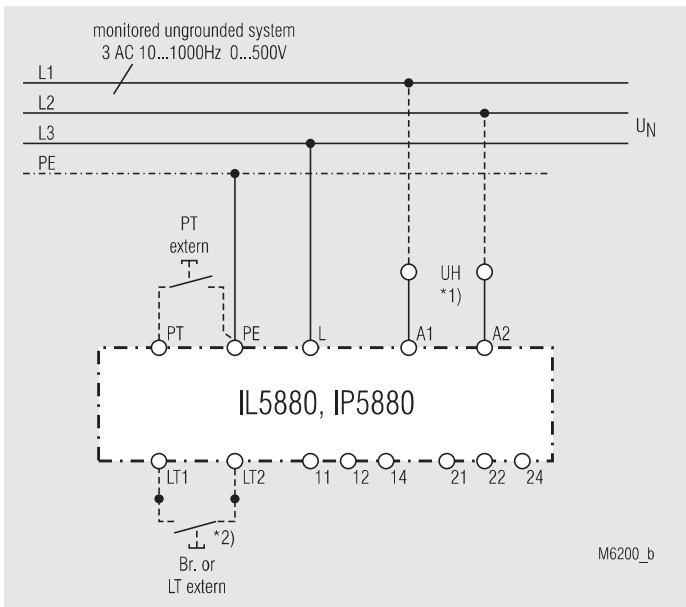

Monitoring of an ungrounded voltage system.

- *1) Auxiliary supply U_H (A1 - A2) can be taken from the monitored voltage system. The range of the auxiliary supply input must be observed.
- *2) with bridge LT1 - LT2: automatic reset
without bridge LT1 - LT2: manual reset, reset with button LT

Connection Example

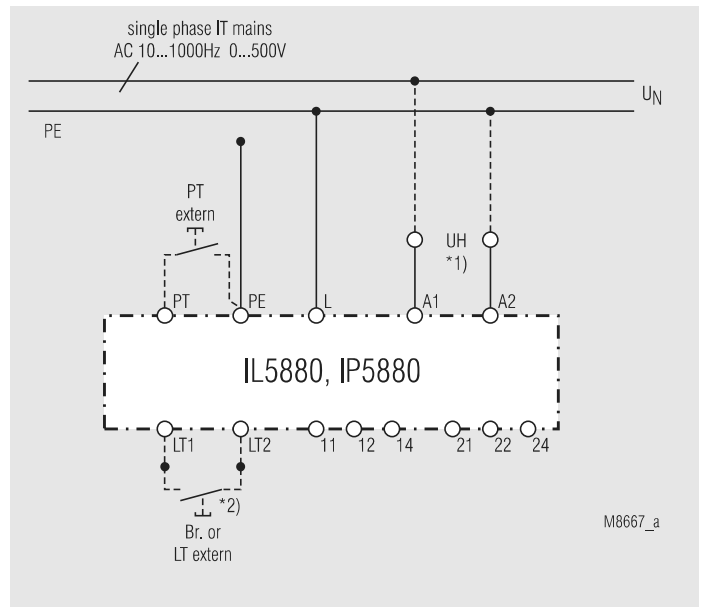

Monitoring of an ungrounded voltage system.

- *1) Auxiliary supply U_H (A1 - A2) can be taken from the monitored voltage system. The range of the auxiliary supply input must be observed.
- *2) with bridge LT1 - LT2: automatic reset
without bridge LT1 - LT2: manual reset, reset with button LT

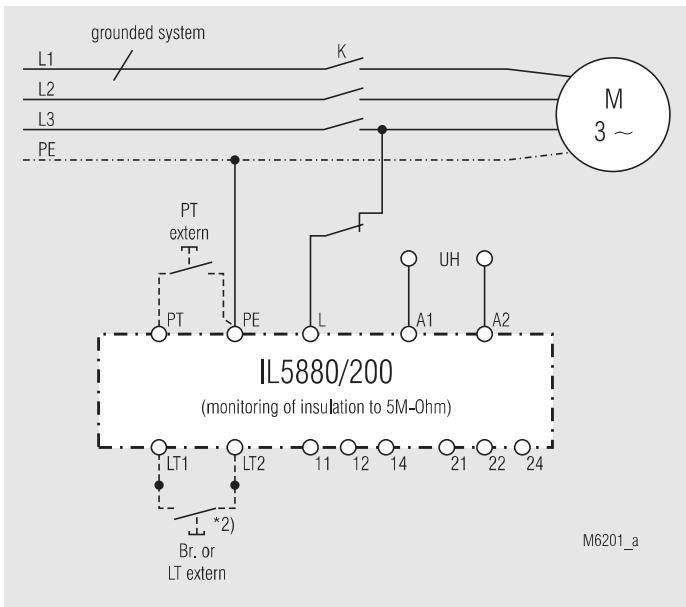

Monitoring of motorwindings against ground.

The insulation of the motor to ground is monitored as long as contactor K does not activate the load.

- *2) with bridge LT1 - LT2: automatic reset
without bridge LT1 - LT2: manual reset, reset with button LT