

**WARNING**

The installation technician shall operate in full compliance with all the applicable technical standards in order to grant the unit safety.

**DESCRIPTION OF THE KEYS**

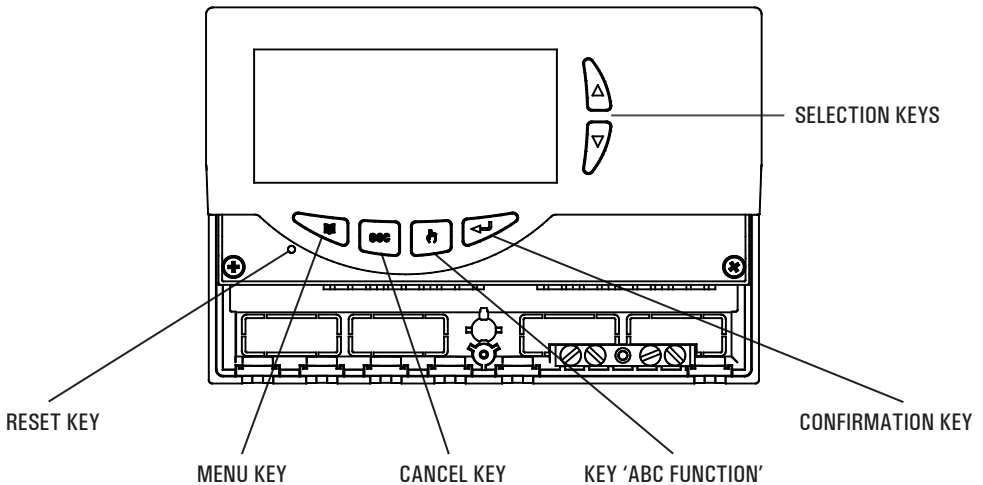

## OVERVIEW

This device is a centralized control unit for thermal solar panels. Equipped with 3 relay outputs (2 for loads + 1 for alarm), PWM output, 0..10V output and 3 inputs (sensors), can configure and manage up to 6 different types of solar systems. When a specific installation is selected, the control unit automatically manages the outputs and inputs used to control the valves, the pumps, the integrative sources and the probes used in the type of installation selected.

Moreover on the backlit LCD display it is possible to visualize the hydraulic diagram of the installation set up, the state of the outputs, the probes as well as several other data and informations.

## AVAILABLE ACCESSORIES AND SPARES

- Accessories for free contacts: 2 x 230V ~ inputs and 2 free voltage outputs
- NTC probe 10K Ohm @25°C ±1%, -50°C .. +200°C (blue cable)
- NTC probe 10K Ohm @25°C ±1%, -50°C .. +110°C (yellow cable)
- Brass pocket 1/2" 7x38mm

## TECHNICAL FEATURES

Power supply:	230V ~ ±10% 50Hz
Power absorption:	< 2 VA
Sensors type:	3 x NTC 10K @ 25 °C ± 1 %
Sensor operating range:	-50 °C .. +200 °C (collector) -50 °C .. +110 °C (boiler)
Temperature reading range:	-20 °C .. 180 °C
Accuracy:	±2 °C
Resolution:	0,1°C (-20°C .. 144,9°C) 1°C (145°C .. 180°C)
Offset adjustment:	on S1: ±5.0°C on S2: ±5.0°C on S3: ±5.0°C
Installer Password:	0000 .. 9999 (default 0000)
Acoustic Signal:	On/Off (default On)
Backlight timing:	20 sec from last keypress
OUT2 Relay Logic:	NOR=N.O. REV=N.C. (default N.O.)

### Contacts rating:

OUT 1 relay:	2(1)A max 250V ~ (SPST) Voltage free
OUT 2 relay:	8(1)A max 250V ~ (SPST) Voltage free
Alarm relay contacts rating:	4(1)A max 250V ~ (SPDT) Voltage free

### Output Signal:

PWM: Amplitude:	10V ±15%
Frequency:	1KHz
Current:	15mA max.

0..10V: Amplitude:	0V..10V ±10%@10V
Minimum load:	10KOhm.
Max allowed PWM / 0...10V cable length:	< 3m.
Protection grade:	IP 40
Type of action:	1
Overvoltage category:	II
Pollution degree:	2
Tracking Index (PTI):	175
Class of protection against electric shock:	II 
Rated impulse voltage:	2500V
Number of manual cycles:	50000
Number of automatic cycles:	100000
Software class:	A
EMC test voltage:	230V ~ 50Hz
EMC test current:	34mA
Distances tolerances fault mode 'short' exclusion:	±0,15mm
Ball pressure test temperature:	75°C
Operating temp. range:	0°C .. 40°C
Storage temp. range:	-10°C .. +50°C
Humidity limits:	20% .. 80% RH non-condensing
Case: Material:	ABS V0 self-extinguishing
Color:	Signal White (RAL 9003)
Dimensions:	156 x 108 x 47 (W x H x D)
Weight:	~ 672 gr. (version with probe) ~ 553 gr. (version without probe)
Installation:	Wall-mount

## CLASSIFICATION UNDER REG. 2013.811.EC

Class:	not applicable
Contribution to energy efficiency:	not applicable

# INSTALLATION



## WARNING!

The installation technician shall operate in full compliance with all the applicable technical standards in order to grant the unit safety

### TO INSTALL THE DEVICE, PERFORM THE FOLLOWING OPERATIONS:

- 1 Remove the central screw and the plastic door.

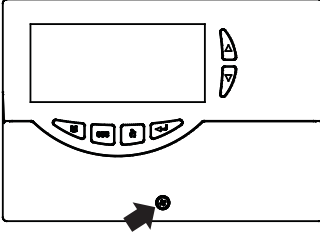

- 2 Remove the two screws shown in the drawing, then remove the whole body from the base.

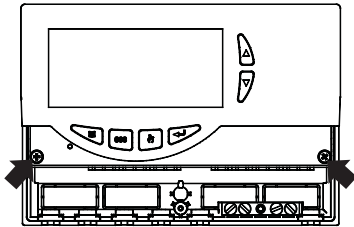

- 3 ASSEMBLY WITH CABLE INPUT ON THE REAR PANEL:  
if the cable fasteners (delivered with the unit) are not required for installation, use a screwdriver to remove the base blocks permitting the cables to pass through, and fit the blocks delivered (6).

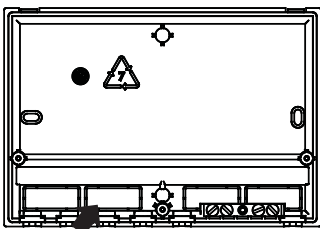

- 4 Fix the power unit base to the wall.

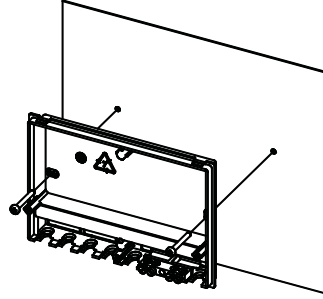

- 5 Fit the cover again with the electronics at the base.

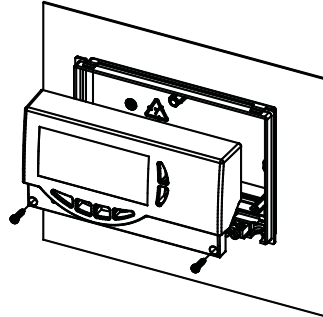

- 6 ASSEMBLY WITH CABLE INPUT ON THE LOWER SIDE:  
fit the cable fasteners and/or the blocks delivered with the unit.

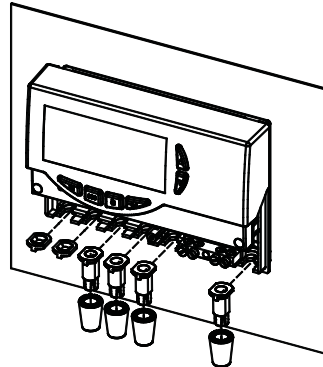

- 7 Make the electrical connections according to the following layout and the examples on page 4 and 5.

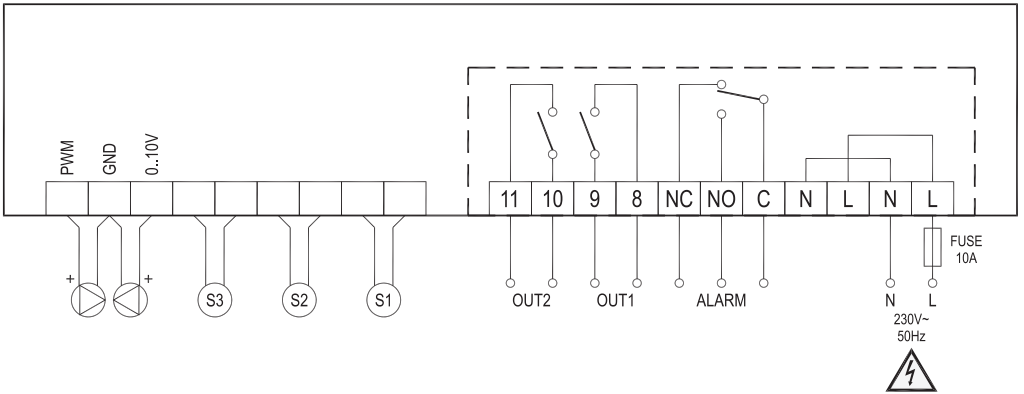

- - : reinforced insulation



**WARNING!**  
Before wiring the appliance be sure to turn the mains power off.

**WARNING!**

It is advisable to fit a 10A 250V ~ fuse on the power unit mains capable to intervene in case of short circuits on loads.

The outputs OUT1, OUT2 and Alarm, are voltage free.

**TERMINAL BOARD GROUNDING:** On the base of the control unit case is located a brass terminal board for connecting the ground protection conductors of the load devices connected to the control unit.

- S1:** you have to use an NTC temperature probe (probe supplied with blue cable) with  $-50^{\circ}\text{C}..+200^{\circ}\text{C}$  range, to connect it to the collector.
- S2:** you have to use an NTC temperature probe (probe supplied with yellow cable) with  $-50^{\circ}\text{C}..+110^{\circ}\text{C}$  range , to connect it to the bottom of the boiler (cold zone).
- S3:** you have to use an NTC temperature probe (probe supplied with yellow cable) with  $-50^{\circ}\text{C}..+110^{\circ}\text{C}$  range , to connect it to the upper part of the boiler (hot zone).

**Standard example for the placement of the three supplied probes:**

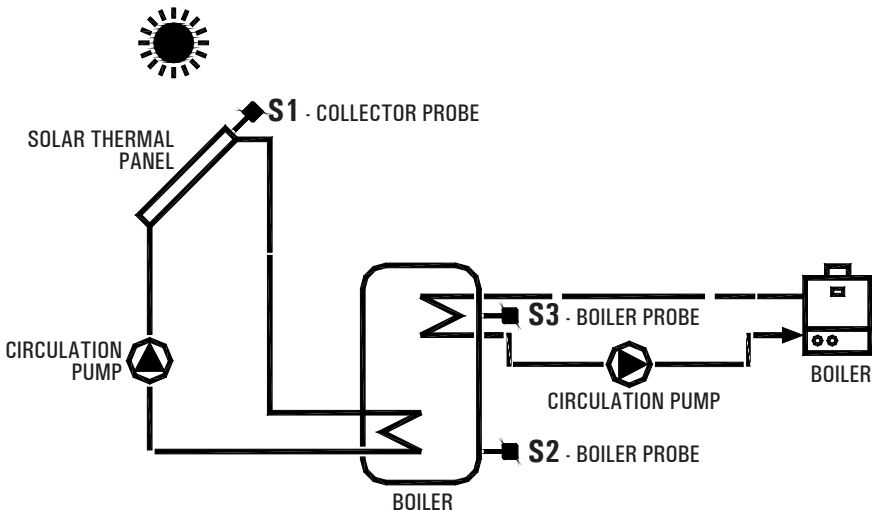

**WIRING EXAMPLE ONLY FOR SOLAR CIRCULATORS IN ACCORDANCE WITH DIRECTIVE ErP 2015 WITH EXTERNAL PWM SIGNAL.**

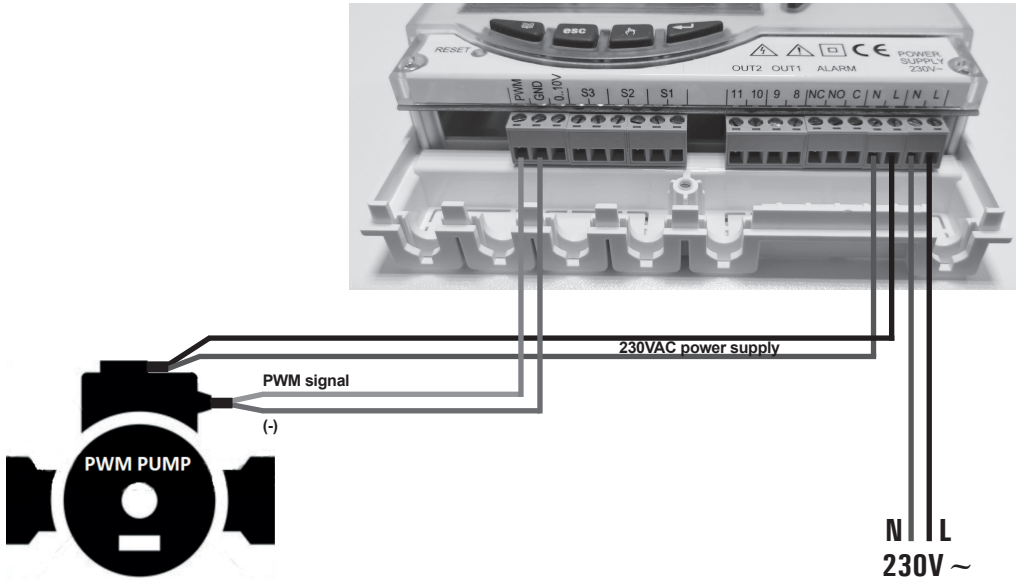

**EXAMPLE OF CONNECTION FOR 3-SPEED SOLAR CIRCULATORS WITH WET or "HIGH EFFICIENCY" ROTOR COMPLIANT WITH DIRECTIVE ErP 2015, WHICH DOES NOT REQUIRE AN EXTERNAL PWM SIGNAL (WITHOUT A CONNECTOR FOR PWM).**

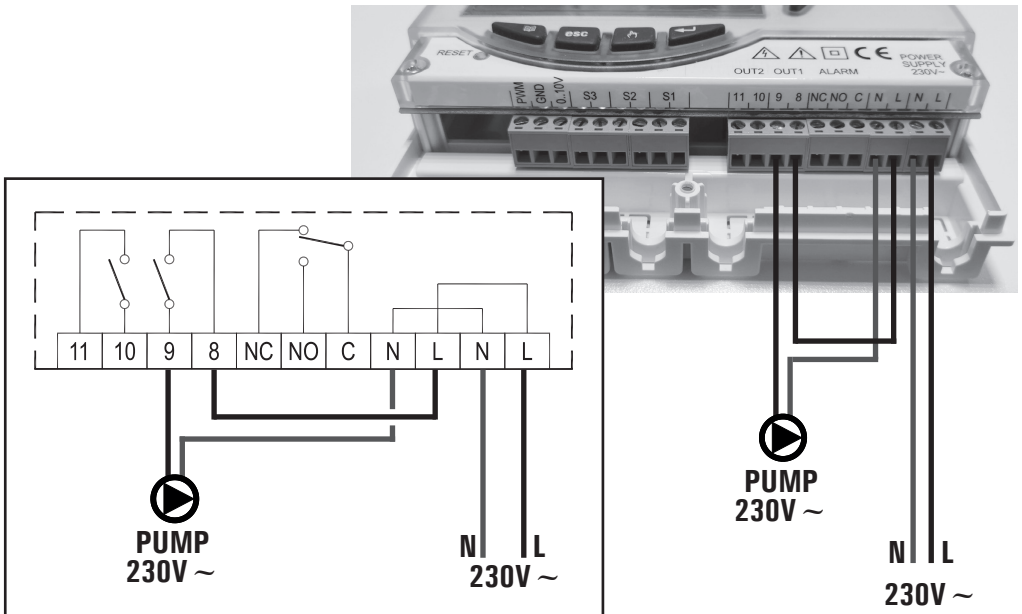

## STARTING

### TURNING ON AND OFF

To turn the control unit on and off, press the 'esc' key for at least 3 seconds. When the control unit is turned on it will carry out a diagnosis of the internal circuitry to verify its correct operation and the red led will flash three times.

If the control unit reveals no anomalies the red led will remain on, otherwise it will continue to flash quickly and the display will show the type of error.

### BACKLIGHT

By pressing any key the backlight of the display is activated. The backlight automatically shuts off after about 20 seconds from the last key depression.

### ACOUSTIC SIGNALS

The control unit is supplied with an internal buzzer that gives the user an acoustic feedback in case of pressure on the keys, alarms and failure. The acoustic signal can be disabled by properly setting the relevant 'Installer Parameter'.

### TEST FUNCTION FOR LOAD WIRINGS CHECK

By keeping pressed for 10 seconds the '🔊' button, the control unit performs the functionality test of the loads connected to it, in order to allow the installer to check the wirings. The control unit checks the connected loads, depending on the configured layout, by simultaneously activating the relays outputs for about 30 seconds, while the PWM outputs will be raised at the maximum speed.

The test activation is showed on the control unit by activating the 'TEST' icon on the display.

To exit the Test mode, push the 'esc' button at any time.

### TEMPERATURE AND SPEED DISPLAY

The unit will normally show on the alphanumeric display the temperature (in °C) measured by the sensors connected and the speed (in %) of the collector pump controlled with the PWM or 0..10V output.

The power on of the collector pump (Erp and/or Traditional) is shown on the display with the icon '🔊' as follows:

Icon '🔊' still lit:	Erp and/or Traditional pumps OFF
Icon '🔊' flashing slow:	Erp Pumps ON and Traditional OFF
Icon '🔊' flashing fast:	Erp Pumps and/or Traditional ON

By pressing the keys '▲' or '▼' you can cycle through the display of the value of the sensor or pump speed:

→ S\_1 → S\_2 → S\_3 → %PWM → %010 →

### AUTOMATIC / ABC (Automatic Boiler Control) OPERATION

The control unit can manage the installation selected in 2 different modes:

#### - AUTOMATIC (Normal controller operation)

In this mode the control unit automatically manages and controls the operation of the installation according to the programmed data (normal controller operation).

#### - ABC (Automatic Boiler Control)

By pressing the '🔊' key you can enable or disable the ABC function on the unit.

When the 'ABC' function is active, the display will turn on the '🔊' icon.

Following are the conditions which result in activating the collector pump:

$S_{_1} \geq TABC + \text{Hysteresis value}$

and

$S_{_1} \geq S_{_2} + \text{Hysteresis value}$

Following are the conditions which result in turning off the collector pump:

$S_{_1} < TABC$

or

$S_{_1} < S_{_2}$

Where:

**S\_1:** Temperature measured by the collector sensor.

**S\_2:** Temperatura measured by the boiler sensor.er.

**TABC:** Temperature set with installer parameter P2.

**Hysteresis value for ABC function:** 3.0°C (fixed - unchangeable)

The only active controls will be those relative to the maximum and safety temperatures.

#### RESET

In order to reset the device, press the key labelled as 'RESET' located behind the removable door; **DO NOT USE PINS OR NEEDLES.**

## INSTALLER PARAMETERS

To access the installer parameters press the '↵' key.

### Entering the Password

The display will show 'PWD 0000' with the leftmost digit flashing thus requesting for the correct password.

In order to set the 4 password digits use the '▲' or '▼' key; by pressing the '↵' key, the current digit is confirmed and the flashing is transferred to the following digit.

After confirming the last digit, the '↵' key will give access to the installer parameters.

The initial password is factory set as '0000'.

### Modifying the Password

In order to modify the stored password, first press the '↵' key, then proceed as follows:

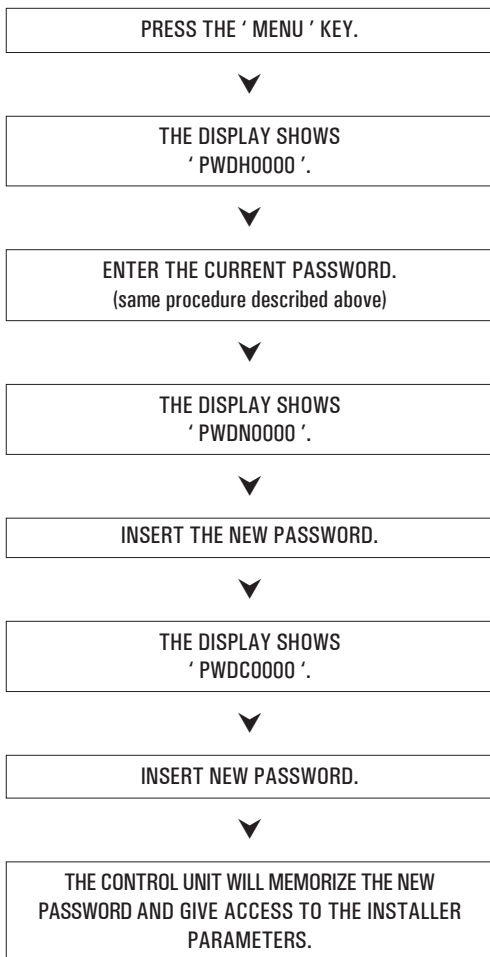

Pressing the 'esc' key at any time will exit the password management mode.

## Using installer parameters

Inserting the correct Password gives access to the installer parameters change mode ('SET' icon lights). The first information displayed is the model of the control unit in use and the parameter 'P1' value.

By pressing the '▲' or '▼' keys it is possible to scroll through the various parameters.

Pressing the '↵' key takes the user to the parameter modifying mode selected.

To exit the installer mode press the 'esc' key or wait 20 seconds.

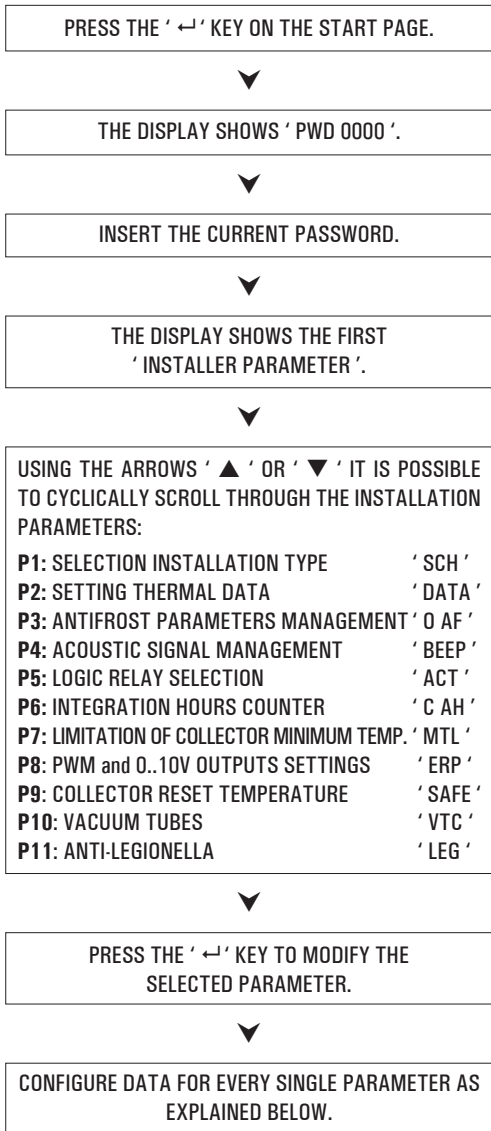

PRESS THE 'esc' KEY TO RETURN TO THE INSTALLER PARAMETERS SELECTION.



WAIT 20 SECONDS OR PRESS THE 'esc' KEY TO EXIT THE INSTALLER MODE.

**Note:** in the 'installer parameters' mode all the outputs are disabled. All default values are to be considered as indicative, being they subject to changes due to the version and without prior notice.

### P1: SELECTION INSTALLATION TYPE

Pressing the '▲' or '▼' keys will show all the installations that can be set up (if the probe for the selected installation has a problem or is left unconnected, that probe will flash on the display).

To confirm the selected installation press the '↵' key; the control unit will memorize the choice and the display will again show the parameter list.

To cancel the selection, press the 'esc' key. In this case the control unit will abandon the changes made and will show again the parameter list.

The parameters influencing the regulation of the selected setup are listed in the following and can be modified through the second installer parameter (P2).

**Note:** When going into parameter P1, the controller will reset the maximum temperatures (MT) detected until that moment. Furthermore, when quitting this parameter, the controller will set again the temperature display on the sensor S<sub>1</sub>.

#### List of programmable thermal parameters (optional):

Parameters	Description
TS1-TS2-TS3	Probe safety temperature
ΔT 12	Differential between the probes S1-S2
MTC	Adjustment of collector minimum temperature
MTEN	Enabling/disabling the collector minimum temperature
TM3	Maximum temperature of the probe S3
TAH	Integration temperature on the probe S3
HY12	Hysteresis of ΔT 12
HYT	Thermostatic hysteresis
HYTS	Safety thermostatic hysteresis



#### WARNING!

The thermal parameters to be set are displayed when the relevant scheme is selected, this means the power unit will only display the thermal parameters actually activated for the selected hydraulic scheme.

## CONTROL LOGIC

**WARNING:** The following control logics must be applied to all the diagram described hereinafter.

### CONTROL LOGIC IN ABC

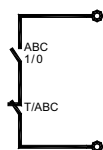

The control logic of the 'ABC' function actually replaces the differential control.

The checks on the Maximum and Safety temperatures are always kept active.

The integrative source is switched off when ABC mode is active.

Once ABC mode is turned off the integrative source will be automatically activated.

### CONTROL LOGIC OF THE SAFETY THERMOSTATS

If an alarm turns on because of an overcoming of the safety temperature, the alarm relay will be activated.

While the loads outputs will keep on functioning according to the relative logics.

In this conditions, the control unit emits a beeping audio signal and on the display will flash the icon "⚠".

The control is not active with the control unit in "OFF" mode (the display shows the message OFF).

#### Condition for the alarm relay activation

The logic of the functioning of the alarm relay, always present in every diagram selected, runs with the following conditions:

TX- ≥ TS- = Alarm relay ON

TX- ≤ (TS- - hysteresys) = Alarm relay OFF

Where:

TX-: Temperature picked up by the connected sensors (S1 .. S3).

TS-: Safety temperature related to the sensors (S1 .. S3).

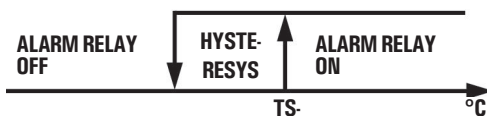

#### Control logic

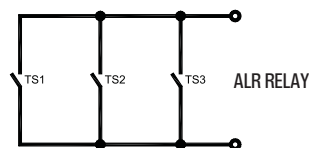



## AVAILABLE DIAGRAMS

### SCH 01

Solar heating installation with 1 tank and no integrative heat source.

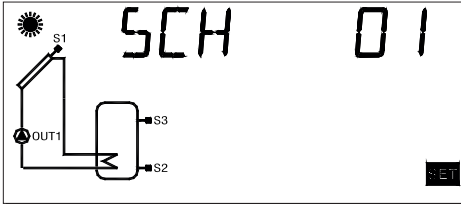

#### Control logic

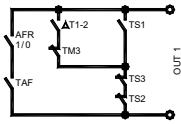

### SCH 04

Solar heating installation with 1 tank, direct integration by means of valve logic.

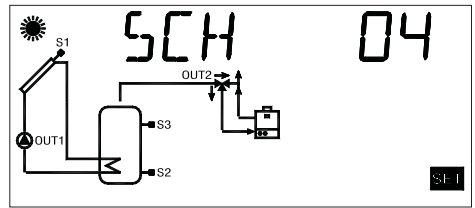

#### Control logic

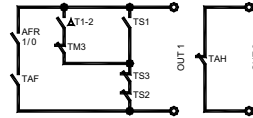

### SCH 02

Solar heating installation with 1 tank and additional thermostatic heating.

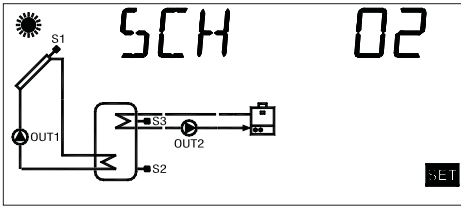

#### Control logic

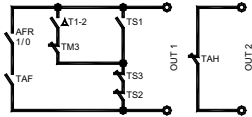

### SCH 05

Natural circulation solar heating installation with 1 tank and direct integration by means of valve logic.

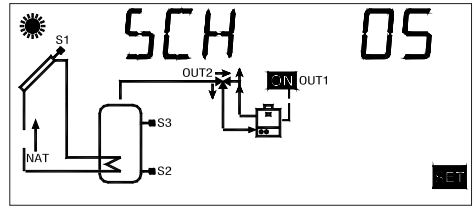

#### Control logic

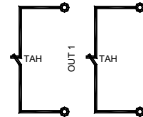

### SCH 03

Pool solar heating installation.

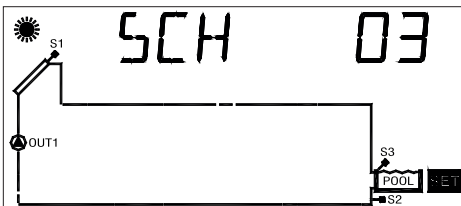

#### Control logic

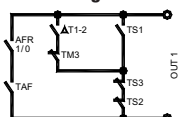

### SCH 06

Solar heating installation with 1 tank and only 2 probe.

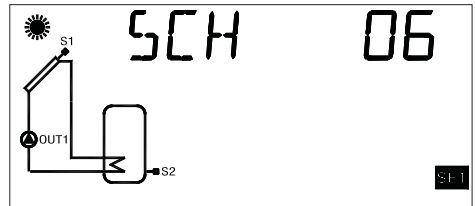

#### Control logic

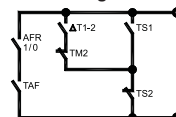

## P2: SETTING THE THERMAL DATA

Using this parameter it is possible to set the thermal data related to the selected installation:

**Note: The control unit is supplied with pre-programmed thermal data for optimal operation. Any change to these values must be performed by qualified personnel only.**

When changing the hydraulic scheme by means of the parameter P1, the thermal values (TS, TM, TAH and TABC) already set will be reset at the default values.

AFTER SELECTING PARAMETER P2 PRESS THE '←' KEY.



USING THE ▲ ' OR ' ▼ ' ARROWS IT IS POSSIBLE TO SCROLL CYCLICALLY THROUGH THE THERMAL DATA:

- Safety temperatures
- Differentials
- Hysteresis of the differentials
- Hysteresis of the safety thermostats
- Hysteresis of the thermostats
- Offset
- Maximum temperatures
- Integration temperature
- ABC (Automatic Boiler Control) temperature



PRESS THE '←' TO MODIFY THE THERMAL DATA SELECTED; THE DATA WILL START FLASHING.



SET THE DESIRED NUMERIC VALUE USING THE '▲' OR '▼' ARROWS.



PRESS THE '←' KEY TO CONFIRM THE PROGRAMMED SETTINGS OR PRESS THE 'esc' KEY TO CANCEL THE CHANGES.

In the following the regulation ranges allowed for each parameter are listed.



### WARNING!

The thermal parameters to be set are displayed when the relevant scheme is selected, this means the power unit will only display the thermal parameters actually activated for the selected hydraulic scheme.

Probe safety temperatures		
Data	Regulation range	Default
TS1	60.0 .. 240.0 °C	140.0 °C
TS2	20.0 .. 90.0 °C	80.0 °C
TS3	20.0 .. 90.0 °C	80.0 °C



### WARNING!

It is not possible to set the Safety Temperatures TS2 and TS3 to a value lower than the relevant Maximum Temperature, as the value of the Safety Temperature is limited to the value of the Maximum Temperature +5°C. To lower the Safety Temperature, it is first necessary to decrease the Maximum Temperature and then set the Safety Temperature to the desired value. If the Safety Temperature is displayed but the relevant Maximum Temperature is not, then the Safety Temperature will be limited according to the Maximum Temperature operating in the current scheme (i.e. in scheme no.1, the value of the TS2 safety temperature will be limited according to the value of the TM3 maximum temperature). Should the hydraulic scheme be changed and SCH5 scheme previously activated, all the Safety and Maximum temperatures will be set at the factory-set default values.

### Differential between the probes S1-S2 ( $\Delta T_{12}$ )

Data	Regulation range	Default
$\Delta T_{12}$	1.0 .. 20.0 °C	8.0 °C



### WARNING!

It is not possible to set the Differential to a value lower than the relevant hysteresis because the value of the Differential is limited to the value of the hysteresis +1°C. To lower the Differential it is first necessary to decrease the value of the hysteresis.

### Hysteresis of the differential $\Delta T_{12}$

Data	Regulation range	Default
HY12	1.0 .. 15.0 °C	4.0 °C



### WARNING!

It is not possible to set the Hysteresis (HY) to a value higher than the relevant Differential ( $\Delta T$ ), because the value of the hysteresis is limited to the value of the Differential -1°C. To increase the value of the Hysteresis it is first necessary to increase the value of the Differential ( $\Delta T$ ).

<b>Hysteresis of the safety temperatures</b>		
Data	Regulation range	Default
HYTS	1.0 .. 15.0 °C	2.0 °C

<b>Thermostatic hysteresis</b>		
Data	Regulation range	Default
HYT	1.0 .. 15.0 °C	2.0 °C

<b>Probe Offset</b>		
Data	Regulation range	Default
OS1	-5.0 .. +5.0 °C	0.0 °C
OS2	-5.0 .. +5.0 °C	0.0 °C
OS3	-5.0 .. +5.0 °C	0.0 °C

<b>Maximum temperature of the probes S2 (TM2) o S3 (TM3)</b>		
Data	Regulation range	Default
TM2	20.0 .. 90.0 °C	70.0 °C
TM3	20.0 .. 90.0 °C	70.0 °C



### **WARNING!**

It is not possible to set the Maximum Temperature (TM) to a value higher than the relevant Safety Temperature, as the Maximum Temperature value is limited to the value of the Safety Temperature (TS) -5°C.

To increase the Maximum Temperature value, it is first necessary to increase the value of the Safety Temperature.

<b>Integration Temperature (After Heating) on probe S3</b>		
Data	Regulation range	Default
TAH	20.0 .. 90.0 °C	45.0 °C



### **WARNING!**

It is not possible to set the value of the integration temperature (TAH) at a value which is higher than the Maximum Temperature (TM3) because the value of the integration temperature (TAH) is linked to the Maximum Temperature (TM3) -5°C.

In order to lower the value of the Maximum Temperature (TM3) below the value of the integration temperature (TAH) already set, first of all lower the value of the integration temperature (TAH), then change the Maximum Temperature (TM3).

<b>ABC Temperature (Automatic Boiler Control) on probe S3</b>		
Data	Regulation range	Default
TABC	20.0 .. 80.0 °C	30.0 °C

### P3: ANTIFROST PARAMETER MANAGEMENT

Using this parameter it is possible to set the data managing the antifrost function.

The control unit is supplied with preset antifrost data for optimal operation.

Any change to these values must be performed by qualified personnel only.

AFTER SELECTING PARAMETER P3 PRESS THE '↵' KEY.



IT IS POSSIBLE TO SCROLL CYCLICALLY THROUGH ANTIFROST DATA USING THE '▲' OR '▼' ARROWS:

- Antifrost temperature 'TAF'
- Collector pump ignition interval 'P ON'
- Collector pump shut off interval 'P OF'
- Antifrost test duration 'TMR'



PRESS THE '↵' KEY TO MODIFY THE THERMAL DATA SELECTED; THE DATA WILL START FLASHING.



USE THE '▲' OR '▼' ARROWS TO SET THE DESIRED NUMERIC VALUE.



PRESS THE '↵' KEY TO CONFIRM THE PROGRAMMING OR PRESS THE 'esc' KEY TO CANCEL THE CHANGES.



BY PRESSING THE '↵' KEY AFTER MODIFYING THE DATA RELATIVE TO THE DURATION OF THE ANTIFROST TEST, THE CONTROL UNIT WILL CONFIRM THE DATA AND WILL START THE TEST.

Antifrost temperature		
Data	Regulation range	Default
TAF	-10.0°C .. +10.0 °C	4.0 °C

Collector pump 'on' time		
Data	Regulation range	Default
P OF	1 .. 60 min.	20 min.

Collector pump 'off' time		
Data	Regulation range	Default
P ON	5 .. 60 sec.	10 sec.

Antifrost test duration		
Data	Regulation range	Default
TMR	5 .. 60 sec.	10 sec.

In the following the regulation ranges allowed for each parameter are listed.

#### P4: ACOUSTIC SIGNAL MANAGEMENT

Using this parameter it is possible to enable or disable the acoustic signalling of the control unit (keyboard tones, alarms, and diagnostics).

Enable (1)/Disable (0) acoustic signal		
Data	Regulation range	Default
BEEP	Off .. On	On

**Note:** 'on' enables acoustic signalling, while 'off' disables it.

#### P5: RELAY LOGIC SELECTION

Using this parameter it is possible to reverse the output logic from Normally Open (N.O.) to Normally Closed (N.C.) and vice-versa. It is only possible to modify the output logic for the relays actually active in the selected setup.

Value '1' for these parameters means that the output logic is reset to the N.O. value (default).

OUT 2 is the only output for which the output logic can be changed.

If the controller displays 'NONE' it means that 'OUT2' is not provided for in the selected layout.

AFTER SELECTING PARAMETER P5 PRESS THE '↵' KEY.



USING THE '▲' or '▼' ARROWS IT IS POSSIBLE TO SCROLL THROUGH THE ACTIVE OUTPUTS.



SELECT THE DESIRED OUTPUT AND PRESS THE '↵' KEY.



CHANGE THE OUTPUT LOGIC USING THE '▲' or '▼' ARROWS.



PRESS THE '↵' KEY TO CONFIRM THE PROGRAMMING OR PRESS THE 'esc' KEY TO CANCEL THE CHANGES.

Output logic for OUT 2		
Data	Regulation range	Default
OUT 2	0 .. 1	1

If the function is not supported by the layout selected the controller will display 'NONE'.

**Note:** '1' means Normally Open (N.O.) logic, while '0' means Normally Closed (N.C.) logic.

## P6: INTEGRATION HOURS COUNTER

Using this parameter it is possible to display the actual number of hours of the integrative source operation or reset it.

AFTER SELECTING PARAMETER P6 PRESS THE '←' KEY.



THE DISPLAY SHOWS 'H' AND ACTUAL HOURS OF ACTIVITY OF THE INTEGRATIVE SOURCE.



PRESS THE '←' KEY, THE DISPLAY SHOWS 'H' FLASHING.



PRESSING THE '←' KEY RESETS THE COUNTER, PRESSING THE 'esc' AGAIN SHOWS THE CURRENT RUNNING HOURS.

The counter recording the running hours of the integrative source can handle values up to 9999. Once the maximum value is reached the counter stops.

## P7: LIMITATION OF COLLECTOR MINIMUM TEMPERATURE

The parameter 'Minimum Temperature Limitation' on collector is used to manage the Minimum Temperature Thermostat used for activation of the collector pumps.

This thermostat stops the pumps operation whenever on the relevant panel is measured a temperature lower than the one set in this parameter.

The function 'Minimum Temperature Limitation' is not active when in ABC operation or in case the pumps activation is caused by the intervention of Recooling or similar functions.

AFTER SELECTING PARAMETER P7 PRESS THE '←' KEY.



WITH ARROWS '▲' OR '▼', YOU CAN CYCLE AMONG THE FOLLOWING THERMAL DATA FOR REGULATION:

- Setting of the collector minimum temperature 'MTC'
- Enabling/Disabling of the minimum temperature limitation 'MTEN'



PRESS THE '←' KEY TO MODIFY THE THERMAL DATA SELECTED; THE DATA WILL START FLASHING.



USE THE '▲' OR '▼' ARROWS TO SET THE DESIRED NUMERIC VALUE.



PRESS THE '←' KEY TO CONFIRM THE PROGRAMMING OR PRESS THE 'esc' KEY TO CANCEL THE CHANGES.

Adjustment of collector minimum temperature		
Data	Regulation range	Default
MTC	10.0°C .. 90.0°C	10.0 °C

Enabling/disabling the collector minimum temperature		
Data	Regulation range	Default
MTEN	0 .. 1	0

**Note:** with '0' the limitation of minimum temperature on collector is disabled, while with '1' it is enabled.

## P8: PWM and 0..10V OUTPUT SETTINGS

With this parameter you can change the settings which control the pump connected to the PWM or 0..10V output of the control unit.

AFTER SELECTING PARAMETER P8 PRESS THE '←' KEY.



WITH ARROWS '▲' OR '▼', YOU CAN CYCLE AMONG THE FOLLOWING THERMAL DATA FOR REGULATION:

- Type of pump connected 'PUMP'
- Operating mode logic 'MODO'
- Pump speed control time 'TIME'
- Fixed point temperature control 'T\_FT'

In the following are listed the parameters whose default value varies depending on whether the parameter 'PUMP' is set to 'REV' (PWM1 / R010V) or 'NOR' (PWM2 / N010V):

- % PWM to turn the pump off '%OFF'
- % PWM to turn the pump on and drive it at maximum speed '%ON'
- % PWM to drive the pump at maximum speed '%MAX'
- Pump flow with PWM = %ON '%FMN'
- 0V .. 10V voltage level to turn the pump off 'VOFF'
- 0V .. 10V voltage level to turn the pump on and drive it at minimum speed 'VON'
- 0V .. 10V voltage level to drive the pump at Maximum speed with 100% flow 'VMAX'
- Pump flow with 0..10V = VON 'VFMN'



PRESS THE '←' KEY TO MODIFY THE THERMAL DATA SELECTED; THE DATA WILL START FLASHING.



USE THE '▲' OR '▼' ARROWS TO SET THE DESIRED NUMERIC VALUE.



PRESS THE '←' KEY TO CONFIRM THE PROGRAMMING OR PRESS THE 'esc' KEY TO CANCEL THE CHANGES.

In the following the regulation ranges allowed for each parameter are listed.

Setting the connected pump functioning logic		
Data	Regulation range	Default
PUMP	REV .. NOR	NOR

### Settings details

#### 'REV' setting

##### PWM output:

The pump connected on the PWM output works according to the "PWM1" standard, or heating logic, also said 'reversed'. With the PWM output at minimum value (0%) the pump runs at full speed, while with the PWM output at maximum value (100%) the pump runs at minimum speed. Of course the pump will operate to all the intermediate speeds through the modulation of the PWM signal between 0% and 100%.

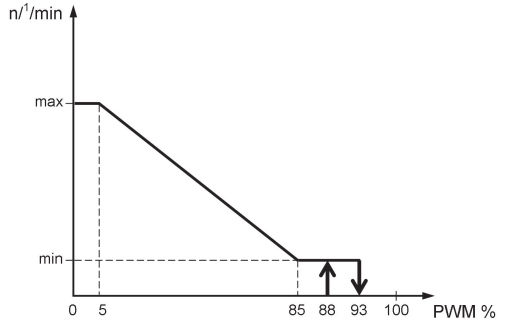

##### 0..10V output:

The pump connected on the 0..10V output works according to the 0V .. 10V 'reversed' standard (R010V). With the 0V ..10V output at minimum value (0V) the pump runs at full speed, while with the 0V ..10V output at maximum value (10V) the pump runs at minimum speed. Of course the pump will operate to all the intermediate speeds through the modulation of the 0 .. 10V signal between 0V and 10V.

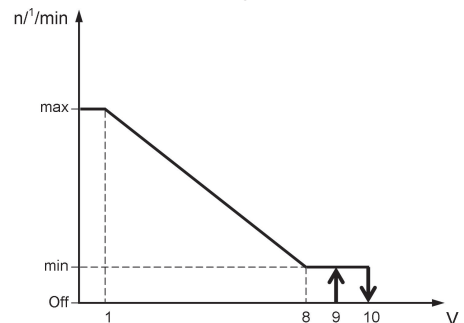

#### 'NOR' setting

##### PWM output:

The pump connected on the PWM output works according to the "PWM2" standard, or solar logic, also said 'normal'. With the PWM output at minimum value (0%) the pump runs

at minimum speed, while with the PWM output at maximum value (100%) the pump runs at full speed. Of course the pump will operate to all the intermediate speeds through the modulation of the PWM signal between 0% and 100%.

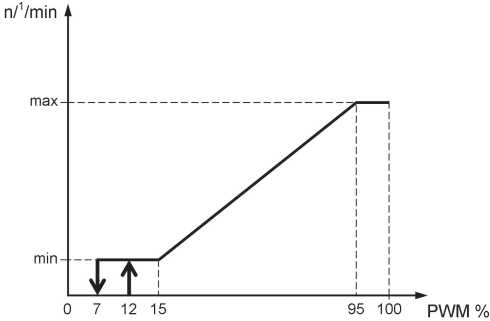

**0..10V output:**

The pump connected on the 0..10V output works according to the 0V .. 10V 'normal' standard (NO10V). With the 0V ..10V output at minimum value (0V) the pump runs at minimum speed, while with the 0V ..10V output at maximum value (10V) the pump runs at full speed. Of course the pump will operate to all the intermediate speeds through the modulation of the 0 .. 10V signal between 0V and 10V.

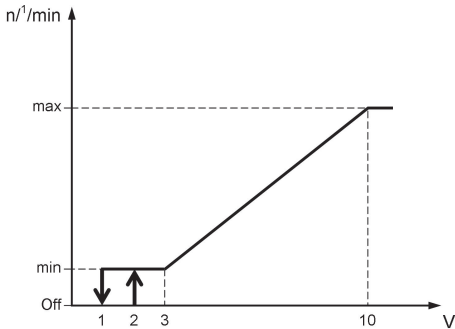

Setting the regulation mode of the PWM pump		
Data	Regulation range	Default
MOD0	MPT / MFT / MdT	MPT

**Settings details**

**Setting MPT (differential proportional mode)**

The proportional regulation of the collector pump speed is performed, by confronting the measured temperature  $\Delta Tr$  (Collector Temp. - Boiler Temp.) with the temperature  $\Delta T$  set by the installer parameter P2. The sampling of the variables to control the speed of the collector pump is performed every 500 milliseconds.

If the control unit is set with the ABC function activated, the collector pump speed, if it is ON, will be equal to the set

value %MAX or VMAX, while, if it is OFF, will be equal to the set value %OFF or VOFF.

If the collector pump is switched on after the intervention of the ABC function, the regulation of the pump rotation speed WILL NOT be proportional to  $\Delta Tr$ .

The proportional regulation of the collector pump speed to  $\Delta Tr$ , is taking into account the functioning logic (REV or NOR) set by the parameter ERP P8 - PUMP:

**When parameter PUMP = NOR (PWM2)**

$\Delta Tr < 0$ : The pump takes its speed at level %OFF or VOFF.

$0 \leq \Delta Tr < \Delta T$ : The pump will have a variable rotation speed between %ON and %MAX or between VON and VMAX, depending on the comparison of  $\Delta Tr$  and  $\Delta T$ .

$\Delta Tr \geq \Delta T$ : The pump will have a rotation speed equal to %MAX or VMAX.

To set the reference data, see parameter P8 - Parameters related to PWM (PWM2) or 0..10V (NO10V) output.

**When parameter PUMP = REV (PWM1)**

$\Delta Tr < 0$ : The pump takes its speed at level %OFF or VOFF.

$0 \leq \Delta Tr \leq \Delta T$ : The pump will have a variable rotation speed between %ON and %MAX or between VON and VMAX, depending on the comparison of  $\Delta Tr$  and  $\Delta T$ .

$\Delta Tr > \Delta T$ : The pump will have a rotation speed equal to %MAX or VMAX.

To set the reference data, see the parameter P8 - Parameters related to PWM (PWM1) or 0..10V (RO10V) output.

**MFT settings (fixed mode)**

The regulation of the collector pump speed is performed referring the regulation to the temperature value  $T_{FT}$  (Fixed point temperature control).

If the temperature on the reference sensor (collector) is higher than the set value  $T_{FT}$ , then the collector pump speed raises until reaching the maximum value only after the 'TIME' control has elapsed.

If the temperature measured by the reference sensor (collector) is lower than the value set for  $T_{FT}$ , then the speed is decreased down to the minimum value only after the 'TIME' control time has elapsed.

**MdT settings (differential mode)**

The regulation of the collector pump speed is performed, by confronting the measured differential temperature  $\Delta Tr$  (Collector Temp. - Boiler Temp.) with the differential temperature  $\Delta T$  set by the installer parameter P2.

If the measured differential temperature ( $\Delta Tr$ ) between the collector and accumulation probes is higher than the set temperature differential ( $\Delta T$ ) for the solar regulation, the



collector pump speed raises gradually until it reaches the maximum set speed only after the ' TIME ' period control has elapsed.

If the differential temperature ( $\Delta T_r$ ) measured between the reference sensors is lower than the set differential temperature ( $\Delta T$ ) for the solar regulation, so the collector pump speed is reduced until the minimum set speed is reached only after the ' TIME ' period control has elapsed.

If the central unit lowers the collector pump speed until it reaches the minimum value %ON or VON and the  $\Delta T_r$  (differential between the sensors) is still lower than the set  $\Delta T$ , so the pump turns OFF taking itself to the level %OFF or VOFF.

Collector pump speed control time		
Data	Regulation range	Default
TIME	1 .. 15 minuti	4 minuti

### TIME parameter detail

Sets the maximum time used to drive the pump from the minimum to maximum speed and vice versa, in order to prevent abrupt changes or oscillations in the system regulation.

Fixed mode temperature control		
Data	Regulation range	Default
T_FT	0 °C .. 90 °C	60 °C

**Note:** this parameter is active only when the option MFT is selected under 'MODE' parameter.

*In the following are listed the parameters and relevant default values when parameter ' PUMP ' is set to ' REV '*

Data	Regulation range	Default
Parameters for PWM (PWM1) output		
%OFF	%ON .. 100%	100%
%ON	%MAX .. %OFF	90%
%MAX	0% .. 50%	0%
%FMN	0% .. 100%	30%
Parameters for 0..10V (R010V) output		
VOFF	VON .. 10,0V	9,0V
VON	VMAX .. VOFF	9,0V
VMAX	0,0V .. 5,0V	0,0V
VFMN	0% .. 100%	30%

*In the following are listed the parameters and relevant default values when parameter ' PUMP ' is set to ' NOR '*

Data	Regulation range	Default
Parameters for PWM (PWM2) output		
%OFF	0% .. %ON	0%
%ON	%OFF .. %MAX	10%
%MAX	50% .. 100%	100%
%FMN	0% .. 100%	30%
Parameters for 0..10V (N010V) output		
VOFF	VON .. 10,0V	9,0V
VON	VMAX .. VOFF	9,0V
VMAX	0,0V .. 5,0V	0,0V
VFMN	0% .. 100%	30%

## P9: COLLECTOR RESET TEMPERATURE

With this parameter you can set the 'T\_SF' temperature value used for the collector pump reset when the TS\_2 safety temperature is reached, in order to avoid thermal shock and air pockets in the system.

The collector pump will automatically restart only if the collector temperature measured with sensor TS\_1 is below the T\_SF collector reset temperature.

AFTER SELECTING PARAMETER P9 PRESS  
THE '←' KEY.



THE DISPLAY SHOWS 'T\_SF'.



PRESS '←'. THE DISPLAY  
SHOWS 'T\_SF' FLASHING.



PRESS ARROWS '▲' and '▼' TO SET  
THE DESIRED VALUE.



PRESS THE '←' KEY TO CONFIRM THE  
PROGRAMMING OR PRESS THE 'esc' KEY TO CANCEL  
THE CHANGES.

Collector reset temperature		
Data	Regulation range	Default
T_SF	OFF / 60 °C .. 180 °C	OFF

## P10: VACUUM TUBES

In some solar systems, for example when vacuum tubes are installed, the collector temperature measurement could be slow, because of its non optimal position.

By enabling the function you can choose between two different operating programs:

**P\_1** where VTC function is enabled and Boiler safety thermostats are prioritized.

**P\_0** where VTC function is enabled and both Boiler and collector pump safety thermostats are disabled.

By enabling the VTC, the following collector pump control is started:

If the collector sensor temperature increases by the amount set in the subparameter 'INC' within one minute, then the collector pump will be operated for the time set in the subparameter 'TIME'.

After the activation of the pump for the time set in the subparameter 'TIME', the function will be off for 5 minutes.

AFTER SELECTING PARAMETER P10 PRESS  
THE '←' KEY.



WITH ARROWS '▲' OR '▼', YOU CAN CYCLE AMONG  
THE FOLLOWING DATA FOR REGULATION:

- Enable parameter 'ENA'
- Increase temperature 'INC'
- Pump activation lapse 'TIME'



PRESS THE '←' KEY TO MODIFY THE DATA  
SELECTED; THE DATA WILL START FLASHING.



USE THE '▲' OR '▼', ARROWS TO SET THE  
DESIRED NUMERIC VALUE.



PRESS THE '←' KEY TO CONFIRM THE  
PROGRAMMING OR PRESS THE 'esc' KEY TO  
CANCEL THE CHANGES.

Enable parameter		
Data	Regulation range	Default
ENA	OFF / P_1 / P_0	OFF



### WARNING!

By enabling parameter 'ENA' in 'P\_0', the boiler safety thermostats are disabled and consequently the boiler temperatures could exceed the safety thresholds set.

Increase temperature		
Data	Regulation range	Default
INC	1 °C/min. .. 10 °C/min.	3°C/min.

Pump activation lapse		
Data	Regulation range	Default
TIME	2 sec. .. 30 sec.	5 sec.

## P11: ANTI-LEGIONELLA

Through this parameter you can enable or disable the Anti-legionella function.

The anti-Legionella (function activated by default) consists of a boiler's water heating cycle at 65°C every 30 days for 5 minutes (in order to carry out thermal disinfection action against the related bacteria) only in case the water in the tank has not been driven at least once at 65°C for 5 minutes without interruptions.

The 30-day counter is reset whenever the water temperature in the boiler reaches 65°C at least for 5 minutes.

If the water, during the heating cycle in the boiler, does not reach 65°C for 5 minutes within one hour, the control unit emits an acoustic signal and the display shows, on the hydraulic diagram, the icon of a flashing boiler. In this alarm situation, the control unit forces the water heating in the boiler and if that succeeds automatically resets the alarm. Otherwise, after entering the parameter P16 "LEG" select the sub-parameter "RS L"; the control unit exits from the alarm condition resetting the 30-day counter.

The Anti-Legionella function can be enabled only for hydraulic schemes which provide additional heating: diagrams 02 (selectable in the installer parameter P1).

AFTER SELECTING PARAMETER P11 PRESS THE ' ← ' KEY.



WITH THE ARROWS ' ▲ ' OR ' ▼ ', YOU CAN SCROLL CYCLICALLY THROUGH THE FOLLOWING SETTING PARAMETERS:

- Enabling the anti-legionella function ' EN L '
- Alarm reset ' RS L '



PRESS THE ' ← ' KEY TO ENTER SELECTED PARAMETER SETTINGS;  
THE PARAMETER STARTS TO BLINK.



WITH THE ARROWS ' ▲ ' OR ' ▼ ', ENABLE / DISABLE THE SELECTED PARAMETER.



PRESS THE ' ← ' KEY TO CONFIRM THE PROGRAMMING OR PRESS THE ' esc ' KEY TO CANCEL THE CHANGES.

The setting ranges for each individual data are listed below.

Enabling the anti-legionella function		
Data	Regulation range	Default
EN L	0 .. 1	1

**Note:** with '0', the function is disabled, while with '1' the function is activated.

Alarm Reset / Reset of the 30-days counter.		
Data	Regulation range	Default
RS L	0 .. 1	0

**Note:** Selecting '1' the control unit exits from the alarm mode, resetting the 30 days' counter.



### WARNING!

- When the Anti-Legionella function is enabled, both maximum TM and safety TS temperatures, if they are lower, are automatically set to the following values:  
TM: TLEG + 5.0°C  
TS: TLEG + 10°C
- The temperature value of anti-Legionella is fixed to 65°C, therefore not adjustable.
- The differential value is fixed to 2°C, therefore not adjustable.

## FUNCTIONS ACCESSIBLE TO THE USER

The functions accessible to the user are limited and do not allow setting those data influencing the installation management.

The only operations allowed to the user are the following:

### Turning on / Turning off the control unit

### Enabling / Disabling ABC function in the control unit.

### User menu

PRESS THE '  ' KEY TO ACCESS ' USER PARAMETERS '.



THE FIRST ' USER PARAMETER ' IS SHOWN.



USING THE ' ▲ ' OR ' ▼ ' ARROWS IT IS POSSIBLE TO SCROLL CYCLICALLY THROUGH THE USER PARAMETERS:

U1: SHOWS MAXIMUM TEMPERATURES  
U2: ENABLES / DISABLES ANTIFROST



PRESS THE ' ← ' KEY TO SELECT THE DESIRED PARAMETER.



SET THE DESIRED VALUE FOR EVERY SINGLE PARAMETER AS EXPLAINED BELOW.



PRESS THE ' esc ' KEY TO RETURN TO THE USER PARAMETERS SELECTION MENU.



WAIT 20 SECONDS OR PRESS THE ' esc ' KEY TO QUIT THE USER MODE.



### WARNING!

In the ' USER PARAMETERS ' mode all the outputs are disabled.

### Displaying the Maximum Temperatures recorded

Parameter ' TMAX U1 ' allows to display the maximum temperature recorded in the system for each probe TM-.

PRESS THE ' ← ' KEY  
TO VIEW THE TEMPERATURE.



USING THE ' ▲ ' OR ' ▼ ' ARROWS IT IS POSSIBLE  
TO SCROLL CYCLICALLY THROUGH THE RECORDED  
TEMPERATURES:

TM1 → TM2 → TM3



PRESS THE ' ← ' KEY. THE DISPLAY SHOWS FLASHING  
THE NUMBER OF THE PROBE.  
PRESSING THE ' esc ' KEY RETURNS TO SHOWING  
THE USER PARAMETERS.



PRESSING ' ← ' RESETS THE TEMPERATURE  
RECORDED TO THAT POINT;  
PRESSING ' esc ' RETURNS TO SHOWING THE  
MEMORIZED TEMPERATURE.



PRESS THE ' esc ' KEY TO QUIT THE MAXIMUM  
TEMPERATURE DISPLAY MODE.

### Antifrost Activation

The ' AFR U2 ' parameter (anti-frost) enables or disables the antifrost function. The management of the antifrost data is performed through the user parameters.

PRESS THE ' ← ' KEY;  
THE DISPLAY SHOWS 'AFR' FLASHING.



USING THE ' ▲ ' OR ' ▼ ' ARROWS IT IS POSSIBLE TO  
ENABLE OR DISABLE THE ANTIFROST:

**0: DISABLED**

**1: ENABLED (THE DISPLAY SHOWS ✱)**



PRESS THE ' ← ' KEY TO CONFIRM THE  
PROGRAMMING OR PRESS THE ' esc ' KEY TO QUIT  
USER PARAMETERS.

## TROUBLESHOOTING

ANOMALY	POSSIBLE CAUSE
<p>During normal operation the control unit displays the symbol  and emits an acoustic signal characterized by a series of 'beeps' together with the quick flashing of the red power supply led. The probe originating the problem is flashing on the display.</p>	<p>The control unit has revealed an anomaly on the probe. The display shows the number of the damaged probe and the type of anomaly present.</p> <p><b>COL OPEN</b> <b>S 2 OPEN</b> <b>S 3 OPEN</b> = Probe missing, not properly wired or open (<math>R = \infty</math>) - Probe is detecting a temperature lower than <math>-31^{\circ}\text{C}</math>.</p> <p><b>COL HIGH</b> <b>S 2 HIGH</b> <b>S 3 HIGH</b> = Probe is short circuited (<math>R = 0</math>) or is detecting a temperature higher than <math>200^{\circ}\text{C}</math>.</p> <p><b>---</b> = The probe has detected a temperature included between <math>-30^{\circ}\text{C} \dots -20^{\circ}\text{C}</math></p> <p><b>EEE</b> = The probe has detected a temperature included between <math>+180^{\circ}\text{C} \dots +199^{\circ}\text{C}</math></p>
<p>In the selection of the installation to be realized (installer parameter P1) one or more probes flashing.</p>	<p>The probe is miswired or damaged.</p>

## WARRANTY

In the view of a constant development of their products, the manufacturer reserves the right for changing technical data and features without prior notice. The consumer is guaranteed against any lack of conformity according to the European Directive 2019/771 as well as to the manufacturer's document about the warranty policy. The full text of warranty is available on request from the seller.





---

**SEITRON S.p.A. a socio unico**

**Via del Commercio, 9/11  
36065 - Mussolente (VI) - ITALY  
Tel.: +39.0424.567842  
Fax.:+39.0424.567849  
[www.seitron.it](http://www.seitron.it) - [info@seitron.it](mailto:info@seitron.it)**