

Further documentation and troubleshooting

To find helpful log files in support cases:

- Open the TouchPad Setup Tool.
- Click *Reports*.

Please visit also our website for the latest documentation, videos and information:

<http://www.trivum.com>
<http://service.trivum.com>

If support is needed

Please contact your local trivum dealer or write to:

service@trivum.com

Download links:

trivum ServerAdmin Tool (Windows):
<http://service.trivum.com/win-admintool>

How to update your trivum v8 to v9?

<http://service.trivum.com/v9-update>

v2_201603 - Errors and specifications subject to change without notice.

1. Mounting

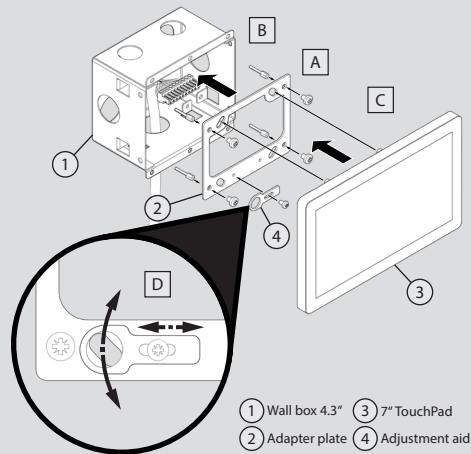

Connector TouchPad side

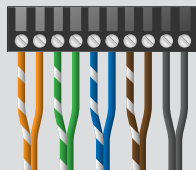

3. MusicCenter binding

- Wait a few seconds until the TouchPad has booted
- On the starting screen press *Pair TouchPad with Audio System*

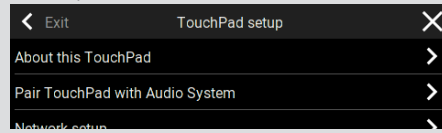

- Press *Select...* and select your preferred trivum MusicCenter from the pop-up menu

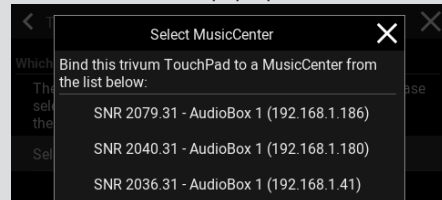

- i Note:** If you want to have the full functionality of your TouchPad 7" please make sure your trivum multiroom system is running version 9.
How to update: <http://service.trivum.com/v9-update>

trivum ⓘ
smart multiroom
We add music to your home

Quick Installation Guide for TouchPad 7"



Optimized for
v9

trivum technologies GmbH
Eierstraße 48
70199 Stuttgart
info@trivum.de
www.trivum.com
www.facebook.com/trivumtechnologies

Quick Installation Guide for TouchPad 7"

Required components for installation:

- Cat 5 cable
- wall box 4.3" (dimensions 104 x 82 x 62 mm)
- PoE Switch

To use the TouchPad in connection with trivum Multiroom Audio System:

- trivum device(s) (e.g. RP, FLEX, AudioBox, ...)
- network DHCP capable router
- music archive (network share, NAS)

Optional components:

- internet connection (required for software updates and remote support)
- KNX/IP-Router (required for using the TouchPad as a KNX room controller)

1. Mounting the TouchPad 7"

1.1 Mount the wall box 4.3".

1.2 Screw the four short screws with the four distance bolts on the adapter plate. 

1.3 Adjust the adapter plate in the wall box to set a proper distance between the TouchPad and the wall. 

1.4 Connect the Cat-5 cable (see illustration „Connector TouchPad side“ on the backside) and plug in.

1.5 Insert the TouchPad in the wall box. 

 **Tip:** TouchPad 7" is usable in landscape or portrait mode

1.6 The adjustment aid should be positioned so that the TouchPad is in balance. 

2. Linking the TouchPad to a trivum device

To link the TouchPad to your trivum device:

2.1 Wait a few seconds until the TouchPad has booted.

2.2 On the starting screen press
Pair TouchPad with Audio System.

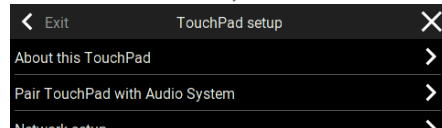

2.3 Press *Select...* and select your preferred trivum MusicCenter from the pop-up menu.

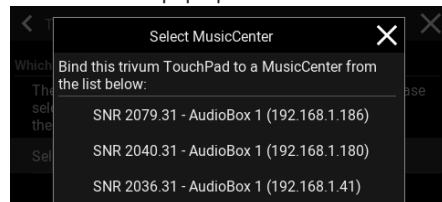

3. Configuring the TouchPad

The trivum TouchPad has to be configured via web browser. To identify the TouchPads IP please go on the TouchPad:

3.1 Press on the right upper corner *trivum*.

3.2 Press *settings* -> *Touchpad settings* -> *Info*.

3.3 Open your web browser and type in the IP to open the trivum TouchPad WebConfig

4. Use your TouchPad as music controller and KNX room controller

Per default the TouchPad is configured as trivum audio controller without any need for KNX.

If your home has a KNX installation, you can use the 7" TouchPad as a smart KNX room controller. You can add simply embedded web objects (e.g. weather forecast, webcams etc.) or KNX objects like dimmer, switches, shutters etc. via the trivum TouchPad WebConfig. The KNX programming of the TouchPad is done via the web browser. No need for extra KNX software.

4.1 Open the trivum TouchPad WebConfig.

4.2 Click *KNX Settings*.

4.3 Enable *Use KNX/IP*.

4.4 Go back to the TouchPad WebConfig main page.

4.5 Click *Page Editor*.

4.6 Move the mouse over the square where you want to place your button and click the "plus-button"

4.7 Choose your preferred APPS or KNX BUTTONS

4.8 Enter the specific settings for this app or the KNX group addresses for this KNX button

You find further informations for KNX on:

<http://service.trivum.com/knx>

 **Tip:** Tap on the date to quickly switch between the music view and the KNX view.

 **Tip:** You can set the default mode of the TouchPad (audio controller / KNX room controller)

- Open the trivum TouchPad Setup Tool.
- Click *Basic Setup*.
- Enable the checkbox *TouchPad mode*.

Backup your configuration

Once you have completed the setup, we recommend you to make a backup of your configuration:

- Open the TouchPad WebConfig.
- Click *Backup/Restore* -> *Export/import configuration*.
- Follow the instructions.